

Photo & Video

November 2024



hama

Brand Overview

hama

Explanation of footnotes

item no. item number

Qty quantity

MB minimum order

PT packaging type

BC blister size

PO polybag

HT hangtag

SC packed in cardboard box

BA banderol

HC hangcard

ET Label

SU Sleeve

HB hangbox

size specifications: W x D x H (width x depth x height)

Contents

Bags & Backbags	5
ActionCam-/GoPro Accessories	27
Smartphone/Tablet Photo Accessories ..	33
Tripods & Accessories	47
Filter & Accessories	57
Accessories for Lenses	63
Camera Accessories	67
Energy	77
Accessories for Flashes	85
Clean & Care	87
Storage Media & Accessories	93
Slide	103
Cinefilm & Video	105
Projection	107
Storage Systeme	111
Cutting Machines	115
Photo-Studio	117
Optical Products	131
Index	133

Bags & Backbags



Photo Bag

COMPACT & COLT BAGS

Compact Bag



hama

Compact Bag
"Hardcase Ambato 60M"

Material	Ethylene Vinyl Acetate (EVA)
Inside Dimensions W x D x H	6,5 x 4,5 x 11 cm

- Robust EVA outer shell
- Opening with double zip fastener
- Flat interior compartment for storage media
- Removable neck strap with snap hook fastener
- Belt loop for more carrying comfort
- With flip-up protection so that the camera cannot fall out of an open bag

Yellow	00121312
10 HC	



hama

Compact Bag
"Hardcase Ambato 80R"

Material	Ethylene Vinyl Acetate (EVA)
Inside Dimensions W x D x H	12 x 6 x 7 cm

- Sturdy EVA outer shell for secure camera protection
- Inner compartment for storage media, etc.
- Two variable inner dividers
- With detachable shoulder strap
- Quick-grab handle
- Belt loops

Yellow	00121318
10 HC	



hama

"Hardcase Carbon Style"
Camera Bag, 60 H, black

Material	Ethylene Vinyl Acetate (EVA)
Inside Dimensions W x D x H	6,5 x 3 x 10,5 cm

- Made of sturdy EVA material
- Flat inner compartment for storage media
- With removable neck strap with snap hook
- Belt loop for carrying convenience

Black	00023139
10 HC	



hama

"Hardcase Carbon Style"
Camera Bag, 60 L, black

Inside Dimensions W x D x H	7 x 4 x 11 cm
-----------------------------	---------------

- Made of sturdy EVA material
- Flat inner compartment for storage media
- With removable neck strap with snap hook
- Belt loop for carrying convenience

Black	00023142
10 HC	



hama

"Hardcase Colour Style"
Camera Bag, 60 H, black

Material	Ethylene Vinyl Acetate (EVA)
Inside Dimensions W x D x H	6,5 x 3 x 10,5 cm

- Made of sturdy EVA material
- Flat inner compartment for storage media
- With removable neck strap with snap hook
- Belt loop for carrying convenience

Black	00103690
10 HC	



hama

"Hardcase Colour Style"
Camera Bag, 60 L, black

Material	Ethylene Vinyl Acetate (EVA)
Inside Dimensions W x D x H	7 x 4 x 11 cm

- Made of sturdy EVA material
- Flat inner compartment for storage media
- With removable neck strap with snap hook
- Belt loop for carrying convenience

Black	00103691
10 HC	



hama

Compact Bag
"Hardcase Colour Style 80L"

Inside Dimensions W x D x H	7 x 4 x 12,5 cm
-----------------------------	-----------------

- Made of sturdy EVA material
- Flat inner compartment for storage media
- With removable neck strap with snap hook
- Belt loop for carrying convenience

Black	00103860
10 HC	



hama

"Hardcase Colour Style"
Camera Bag, 80M, black

Inside Dimensions W x D x H	7,5 x 4,5 x 12,5 cm
-----------------------------	---------------------

- Made of tough EVA material
- Flat inner compartment for storage media
- Padded lining for protecting the camera from shocks
- Removable neck strap with a snap hook
- Belt loop for easy, comfortable carrying

Black	00126656
10 HC	



hama

"Hardcase Zip" Camera Bag, 80 M, black/blue

Material	Ethylene Vinyl Acetate (EVA)
Inside Dimensions W x D x H	7.5 x 4.5 x 12.5 cm

- Robust EVA outer shell
- Dual zipper opening
- Flat inner compartment for storage media
- Removable neck strap with a snap hook
- Belt loop for carrying convenience

Black, Blue	00139835
10 HC	



hama

Compact Bag "Fancy Sporty 80M"

Material	Polyester, Ripstop
Inside Dimensions W x D x H	7.5 x 4.5 x 12.5 cm

- Main compartment with double zipper opening
- Extra zipped compartment on the lid for memory cards and batteries
- Neck strap with a snap hook
- Belt loop for convenient carrying
- The inside lining is made of soft fleece and protects the camera from scratches

Black	00139820
10 HC	



hama

Compact Bag "Fancy Urban 80M"

Material	Polyester, Ripstop
Inside Dimensions W x D x H	7.5 x 4.5 x 12.5 cm

- Main compartment with double zipper opening
- Extra zipped compartment on the lid for memory cards and batteries
- Neck strap with a snap hook
- Belt loop for convenient carrying
- The inside lining is made of soft fleece and protects the camera from scratches

Grey	00139825
10 HC	



hama

"Matera" Camera Bag, 90M, black

Material	Recycled Polyester (R-PET)
Inside Dimensions W x D x H	7.5 x 4.5 x 13 cm

- Both the inner and outer material are made from 100% recycled polyester
- Resource-sparing production from recycled PET materials that can be processed into yarn
- Main compartment with dual-zip opening
- Special compartment on the cover for memory cards and batteries

Black	00121333
10 HC	



hama

Compact Bag "Fancy Sporty 60H"

Material	Polyester, Ripstop
Inside Dimensions W x D x H	6,5 x 3 x 11 cm

- Main compartment with double zipper opening
- Extra zipped compartment on the lid for memory cards and batteries
- Neck strap with a snap hook
- Belt loop for convenient carrying
- The inside lining is made of soft fleece and protects the camera from scratches

Black	00139818
10 HC	



hama

Compact Bag "Fancy Urban 60H"

Material	Polyester, Ripstop
Inside Dimensions W x D x H	6,5 x 3 x 11 cm

- Main compartment with double zipper opening
- Extra zipped compartment on the lid for memory cards and batteries
- Neck strap with a snap hook
- Belt loop for convenient carrying
- The inside lining is made of soft fleece and protects the camera from scratches

Grey	00139823
10 HC	



hama

"Matera" Camera Bag, 60H, black

Material	Recycled Polyester (R-PET)
Inside Dimensions W x D x H	6,5 x 3 x 11 cm

- Both the inner and outer material are made from 100% recycled polyester
- Resource-sparing production from recycled PET materials that can be processed into yarn
- Main compartment with dual-zip opening
- Special compartment on the cover for memory cards and batteries

Black	00121332
10 HC	



hama

"Samara" Camera Bag, 40H, black

Material	Polytex, Polytex (GOOD)
Inside Dimensions W x D x H	6 x 3 x 9.5 cm

- Zip opening
- Belt loop (45 mm wide) for more carrying comfort
- Cut-out for camera strap on the back of the bag
- Soft fleece inside lining to protect the camera from scratches
- Small internal fleece pocket, e.g. for memory cards or batteries

Black	00185079
10 HC	

Photo Bag

COMPACT & COLT BAGS



hama

"Samara" Camera Bag, 60G, black

Material	Polytex (600D)
Inside Dimensions W x D x H	6 x 2.5 x 10.5 cm

- Zip opening
- Belt loop (40 mm wide) for more carrying comfort
- Cut-out for camera strap on the back of the bag
- Soft fleece inside lining to protect the camera from scratches
- Small internal fleece pocket, e.g. for memory cards or batteries

Black	00185080
	10 HC



hama

"Terra" Camera Bag, 60 H, grey

Material	Recycled Polyester (R-PET)
Inside Dimensions W x D x H	6,5 x 3 x 11 cm

- The "Terra" range is synonymous with sustainable, high-quality products that are good for both you and the environment
- Both the inner and outer material are made from 100% recycled polyester
- Resource-sparing production from recycled PET materials that can be processed into yarn

Grey	00121301
	10 HC



hama

"Terra" Camera Bag, 90 M, grey

Material	Recycled Polyester (R-PET)
Inside Dimensions W x D x H	7,5 x 4,5 x 13 cm

- The "Terra" range is synonymous with sustainable, high-quality products that are good for both you and the environment
- Both the inner and outer material are made from 100% recycled polyester
- Resource-sparing production from recycled PET materials that can be processed into yarn

Grey	00121302
	10 HC



hama

"Valletta" Camera Bag, 60G, black

Material	Polytex
Inside Dimensions W x D x H	6 x 2.5 x 10.5 cm

- Belt loop for carrying comfort
- Cover flap with hook and loop fastener

Black	00185068
	10 HC



hama

"Valletta" Camera Bag, 60L, black

Material	Polytex
Inside Dimensions W x D x H	6 x 4 x 11 cm

- Belt loop for carrying comfort
- Cover flap with hook and loop fastener

Black	00185069
	10 HC



hama

"Valletta" Camera Bag, 90P, black

Material	Polytex
Inside Dimensions W x D x H	7,5 x 5,2 x 13 cm

- Cover flap with hook and loop fastener
- Additional front compartment with zip fastener
- Detachable shoulder strap
- Belt loop for carrying comfort

Black	00185070
	10 HC

Colt Bag



hama

"Albany HC" Camera Bag, 110 Colt, black

Material	Polytex (600D)
Inside Dimensions W x D x H	15 x 10 x 14 cm
Weight	280 g

- Main opening with two-way zip fastener
- Zipped front pocket for accessories such as cables, memory cards and batteries
- Mesh side pockets
- Belt loop for more carrying comfort
- Padded handle
- Adjustable, removable shoulder strap
- Stable bag base made from sturdy and resilient EVA material

Black	00185062
	12 HT



hama

"Matera" Camera Bag, 100
Colt, black

Material	Recycled Polyester (R-PET)
Inside Dimensions W x D x H	13.5 x 9.5 x 12 cm
Weight	230 g

- Both the inner and outer material are made from 100% recycled polyester
- Resource-sparing production from recycled PET materials that can be processed into yarn
- Double-zipper opening for easy handling
- Compartment under the cover for storage media and accessories
- Front compartment with zip fastener
- 2 side compartments
- Wipeable base
- Detachable shoulder strap
- Belt loop for easy carrying
- Quick-grab handle
- 2 adjustable inner dividers

Black				00121335
	18	HT		



hama

"Matera" Camera Bag, 110
Colt, black

Material	Recycled Polyester (R-PET)
Inside Dimensions W x D x H	16 x 10 x 16 cm
Weight	300 g

- Both the inner and outer material are made from 100% recycled polyester
- Resource-sparing production from recycled PET materials that can be processed into yarn
- Double-zipper opening for easy handling
- Compartment under the cover for storage media and accessories
- Front compartment with zip fastener
- 2 side compartments
- Wipeable base
- Detachable shoulder strap
- Belt loop for easy carrying
- Quick-grab handle
- 2 adjustable inner dividers

Black				00121336
	12	HT		



hama

"Monterey" Camera Bag, 100
Colt, black

Material	Polytex
Inside Dimensions W x D x H	13.5 x 9.5 x 12 cm
Weight	325 g

- High-quality camera bag in classic design
- Cover construction with zip that opens away from the body
- Soft fleece inside lining to protect the camera from scratches
- Compartment for memory cards, etc. under the cover
- Zipped compartment on the outside for storage media and batteries
- Two side mesh pockets
- Document compartment on the back
- Belt loop for more carrying comfort
- Length-adjustable, removable shoulder strap
- Soft handle
- Rain protection hood integrated into the lower part of the back section
- Wipeable base

Black				00139894
	18	HT		



hama

"Monterey" Camera Bag, 130
Colt, black

Material	Polytex
Inside Dimensions W x D x H	16 x 10 x 21 cm
Weight	425 g

- High-quality camera bag in classic design
- Cover construction with zip that opens away from the body
- Soft fleece inside lining to protect the camera from scratches
- Compartment for memory cards, etc. under the cover
- Zipped compartment on the outside for storage media and batteries
- Two side mesh pockets
- Document compartment on the back
- Belt loop for more carrying comfort
- Length-adjustable, removable shoulder strap
- Soft handle
- Rain protection hood integrated into the lower part of the back section
- Wipeable base

Black				00139896
	4	HT		

Photo Bag

COMPACT & COLT BAGS



hama

"Samara" Camera Bag, 110 Colt, black

Material	Polytex (600D)
Inside Dimensions W x D x H	17 x 10 x 17 cm
Weight	215 g

- Double-zip opening for quick access
- Patch zipped front pocket for accessories
- Length-adjustable shoulder strap
- Handle
- Soft fleece inside lining
- One removable inner divider

Black				00185085
	12	HT		



hama

"Terra" Camera Bag, 100 Colt, grey

Material	Recycled Polyester (R-PET)
Inside Dimensions W x D x H	13.5 x 9.5 x 12 cm
Weight	285 g

- The "Terra" range is synonymous with sustainable, high-quality products that are good for both you and the environment
- Both the inner and outer material are made from 100% recycled polyester
- Resource-sparing production from recycled PET materials that can be processed into yarn
- Compartment under the cover for storage media and accessories
- Double-zipper opening for easy handling
- Front compartment with zip fastener
- Two side compartments
- Wipeable base
- Detachable shoulder strap
- Belt loop for easy carrying
- Quick-grab handle

Grey				00121303
	18	HT		



hama

"Terra" Camera Bag, 110 Colt, grey

Material	Recycled Polyester (R-PET)
Inside Dimensions W x D x H	16 x 10 x 16 cm
Weight	315 g

- The "Terra" range is synonymous with sustainable, high-quality products that are good for both you and the environment
- Both the inner and outer material are made from 100% recycled polyester
- Resource-sparing production from recycled PET materials that can be processed into yarn
- Compartment under the cover for storage media and accessories
- Double-zipper opening for easy handling
- Front compartment with zip fastener
- Two side compartments
- Wipeable base
- Detachable shoulder strap
- Belt loop for easy carrying
- Quick-grab handle

Grey				00121304
	12	HT		



hama

"Valletta" Camera Bag, 90 Colt, black

Material	Polytex
Inside Dimensions W x D x H	13 x 8 x 11 cm
Weight	210 g

- Belt loop for carrying comfort
- Main compartment with zip that opens away from the body
- Additional front compartment with zip fastener
- Two side mesh pockets
- Detachable shoulder strap

Black				00185076
	18	HT		



hama

"Valletta" Camera Bag, 130 Colt, black

Material	Polytex
Inside Dimensions W x D x H	16 x 10 x 21 cm
Weight	300 g

- Two belt loops for comfortable carrying
- Main compartment with zip that opens away from the body
- Additional front compartment with zip fastener
- Two side mesh pockets
- Padded handle
- Detachable shoulder strap

Black				00185078
	8	HT		



hama

"Valletta" Camera Bag, 110 Colt, black

Material	Polytex
Inside Dimensions W x D x H	15 x 9 x 15.5 cm
Weight	220 g

- Belt loop for carrying comfort
- Main compartment with zip that opens away from the body
- Additional front compartment with zip fastener
- Two side mesh pockets
- Padded handle
- Detachable shoulder strap

Black				00185077
	16	HT		

Organizer Bag



hama

Organizer Bag "Fancy", L

Material	Polytex
Outside Dimensions W x D x H	23.5 x 17 x 8 cm
Inside Dimensions W x D x H	22.5 x 7 x 16 cm

- The organiser offers plenty of storage space for electronic devices and photo accessories such as cables, USB sticks, filters or SD cards
- All tidied away and ready at hand, ideal for holidays and when out and about
- 2 main compartments with double zip
- 1 zipped pocket inside for power pack or filters
- 2 mesh pockets inside for mobile phones and photo accessories
- 1 mesh pocket with zip fastener in the second main compartment
- 10 rubber loops for cables, etc.
- 6 mesh pockets for USB sticks or SD cards
- Double-zipper opening

Black				00139875
	10	HC		



hama

Organizer Bag "Fancy", M

Material	Polytex
Outside Dimensions W x D x H	23.5 x 17 x 4.5 cm
Inside Dimensions W x D x H	22.5 x 3.5 x 16 cm

- The organiser offers plenty of storage space for photo accessories such as cables, USB sticks, filters or SD cards
- All tidied away and ready at hand, ideal for holidays and when out and about
- 1 zipped pocket for power pack or filters
- 10 rubberised loops
- 6 mesh pockets for USB sticks or SD cards
- Double-zipper opening

Black				00139874
	20	HC		

Photo Bag

COMPACT & COLT BAGS



hama

**"Fancy" Camera Accessories
Organiser, L (22.5 x 7 x 16
cm)**

- The organiser offers plenty of storage space for electronic devices and photo accessories such as cables, USB sticks, filters or SD cards
- All tidied away and ready at hand, ideal for holidays and when out and about
- 2 main compartments with double zip
- 1 zipped pocket inside for power pack or filters
- 2 mesh pockets inside for mobile phones and photo accessories
- 1 mesh pocket with zip fastener in the second main compartment
- 10 rubber loops for cables, etc.
- 6 mesh pockets for USB sticks or SD cards
- Double-zipper opening

00139536

40 HC

Equipment Bag



hama

"Albany HC" Camera Bag, 110, black

Material	Polytex (600D)
Inside Dimensions W x D x H	15 x 10 x 13 cm
Weight	325 g

- Main opening with two-way zip fastener
- Zipped front pocket for accessories such as cables, memory cards and batteries
- Mesh side pockets
- Belt loop for more carrying comfort
- Padded handle
- Adjustable, removable shoulder strap
- An adjustable internal divider for clear organisation
- Stable bag base made from sturdy and resilient EVA material

Black				00185063
		12	HT	



hama

"Albany HC" Camera Bag, 130, black

Material	Polytex (600D)
Inside Dimensions W x D x H	20 x 11 x 17 cm
Weight	380 g

- Main opening with two-way zip fastener
- Zipped front pocket for accessories such as cables, memory cards and batteries
- Mesh side pockets
- Belt loops for more carrying comfort
- Padded handle
- Adjustable, removable shoulder strap
- Two adjustable inner dividers for clear organisation
- Stable bag base made from sturdy and resilient EVA material

Black				00185064
		8	HT	



hama

"Albany HC" Camera Bag, 135, black

Material	Polytex (600D)
Inside Dimensions W x D x H	22 x 12.5 x 14 cm
Weight	440 g

- Main opening with two-way zip fastener
- Zipped front pocket for accessories such as cables, memory cards and batteries
- Mesh side pockets
- Belt loops for more carrying comfort
- Padded handle
- Adjustable, removable shoulder strap
- Two adjustable inner dividers for clear organisation
- Stable bag base made from sturdy and resilient EVA material

Black				00185065
		8	HT	



hama

"Matera" Camera Bag, 90, black

Material	Recycled Polyester (R-PET)
Inside Dimensions W x D x H	8 x 7.5 x 13 cm
Weight	225 g

- Both the inner and outer material are made from 100% recycled polyester
- Resource-sparing production from recycled PET materials that can be processed into yarn
- Double-zipper opening for easy handling
- Compartment under the cover for storage media and batteries
- Front compartment with zip fastener
- 2 side compartments
- Wipeable base
- Detachable shoulder strap
- Belt loop for easy carrying
- Padded handle
- 1 adjustable inner divider

Black				00121334
		32	HT	

Photo Bag

EQUIPMENT BAGS



hama

"Matera" Camera Bag, 110, black

Material	Recycled Polyester (R-PET)
Inside Dimensions W x D x H	15.5 x 10 x 13 cm
Weight	250 g

- Both the inner and outer material are made from 100% recycled polyester
- Resource-sparing production from recycled PET materials that can be processed into yarn
- Double-zipper opening for easy handling
- Compartment under the cover for storage media and accessories
- Front compartment with zip fastener
- 2 side compartments
- Wipeable base
- Detachable shoulder strap
- Belt loop for easy carrying
- Quick-grab handle
- 1 adjustable inner divider

Black				00121337
	18	HT		



hama

"Matera" Camera Bag, 130, black

Material	Recycled Polyester (R-PET)
Inside Dimensions W x D x H	20 x 10.5 x 16.5 cm
Weight	375 g

- Both the inner and outer material are made from 100% recycled polyester
- Resource-sparing production from recycled PET materials that can be processed into yarn
- Double-zipper opening for easy handling
- Compartment under the cover for storage media and accessories
- Front compartment with zip fastener
- 2 side compartments
- Wipeable base
- Detachable shoulder strap
- Trolley strap
- Quick-grab handle
- 2 adjustable inner dividers

Black				00121338
	8	HT		



hama

"Matera" Camera Bag, 135, black

Material	Recycled Polyester (R-PET)
Inside Dimensions W x D x H	23 x 9.5 x 14 cm
Weight	350 g

- Both the inner and outer material are made from 100% recycled polyester
- Resource-sparing production from recycled PET materials that can be processed into yarn
- Double-zipper opening for easy handling
- Compartment under the cover for storage media and accessories
- Front compartment with zip fastener
- 2 side compartments
- Wipeable base
- Detachable shoulder strap
- Trolley strap
- Quick-grab handle
- 2 adjustable inner dividers

Black				00121339
	8	HT		



hama

"Monterey" Camera Bag, 100, black

Material	Polytex
Inside Dimensions W x D x H	14 x 8 x 11.5 cm
Weight	340 g

- High-quality camera bag in classic design
- Cover construction with zip that opens away from the body
- Soft fleece inside lining to protect the camera from scratches
- Compartment for memory cards, etc. under the cover
- Zipped compartment on the outside for storage media and batteries
- Flat zipped compartment at the back for documents
- Two side mesh pockets
- Belt loop for more carrying comfort
- Length-adjustable, removable shoulder strap
- Handle
- 1 variable internal divider for clear organisation
- Rain protection hood integrated into the lower part of the back section
- Wipeable base

Black				00139888
	16	HT		



hama

"Pittsburgh" Camera Bag, 100, black

Material	Polyester
Inside Dimensions W x D x H	14 x 8 x 11.5 cm
Weight	320 g

- Main compartment with dual-zip opening
- Flat front pocket with two mesh compartments for e.g. batteries
- Additional zip fastener under the cover for e.g. memory cards
- Pocket on the inside of the back of the bag
- 2 external mesh compartments on the sides
- Flexible, adjustable tripod holders under the mesh pockets on the sides
- 1 variable inner divider
- 2 belt loops
- Wipeable base
- Removable and length-adjustable shoulder strap with ergonomically shaped shoulder pad
- Padded handle
- Rain protection hood in the lower part of the back section integrated with hook and eye fastener

Black	00185008
16	HT



hama

"Pittsburgh" Camera Bag, 150, black

Material	Polyester
Inside Dimensions W x D x H	24 x 15 x 20 cm
Weight	625 g

- Main compartment with dual-zip opening
- Flat front pocket with 2 mesh compartments for e.g. batteries
- Additional zip fastener under the cover for e.g. memory cards
- Zipped compartment on the back of the bag
- Pocket on the inside of the back of the bag for a tablet
- 2 external mesh compartments on the sides
- Flexible, adjustable tripod holders under the mesh pockets on the sides
- 4 variable inner dividers
- Trolley strap on the back
- Wipeable base
- Removable and length-adjustable shoulder strap with ergonomically shaped shoulder pad
- Padded handle
- Rain protection hood in the lower part of the back section integrated with hook and eye fastener

Black	00185058
4	HT



hama

"Pittsburgh" Camera Bag, 170, black

Material	Polyester
Inside Dimensions W x D x H	29 x 16 x 20 cm
Weight	725 g

- Main compartment with dual-zip opening
- Flat front pocket with 2 mesh compartments for e.g. batteries
- Additional zip fastener under the cover for e.g. memory cards
- Zipped compartment on the back of the bag
- Pocket on the inside of the back of the bag for a tablet
- 2 external mesh compartments on the sides
- Flexible, adjustable tripod holders under the mesh pockets on the sides
- 6 variable inner dividers
- Trolley strap on the back
- Wipeable base
- Removable and length-adjustable shoulder strap with ergonomically shaped shoulder pad
- Padded handle
- Rain protection hood in the lower part of the back section integrated with hook and eye fastener

Black	00185059
4	HT



hama

"Phoenix" Camera Bag, 130, black

Material	Recycled Polyester (R-PET)
Inside Dimensions W x D x H	23.5 x 16.5 x 20 cm
Weight	460 g

- Main compartment with dual-zip opening
- Flat front pocket with 3 mesh compartments for e.g. batteries
- Zipped compartment on the cover
- Additional zip fastener under the cover for e.g. memory cards
- Zipped external compartment on the back of the bag
- Pocket on the inside of the back of the bag
- 2 external mesh compartments on the sides
- Flexible, adjustable tripod holders under the mesh pockets on the sides
- 2 variable inner dividers
- Trolley strap on the back
- Wipeable base
- Removable and length-adjustable shoulder strap with ergonomically shaped shoulder pad
- Padded handle
- Rain protection hood integrated into the lower part of the back section

	00121348
8	HT

Photo Bag

EQUIPMENT BAGS



hama

"Phoenix" Camera Bag, 135, black

Material	Recycled Polyester (R-PET)
Inside Dimensions W x D x H	26 x 16 x 17.5 cm
Weight	480 g

- Main compartment with dual-zip opening
- Flat front pocket with 2 mesh compartments for e.g. batteries
- Zipped compartment on the cover
- Additional zip fastener under the cover for e.g. memory cards
- Zipped compartment on the back of the bag
- Pocket on the inside of the back of the bag
- 2 external mesh compartments on the sides
- Flexible, adjustable tripod holders under the mesh pockets on the sides
- 2 variable inner dividers
- Trolley strap on the back
- Wipeable base
- Removable and length-adjustable shoulder strap with ergonomically shaped shoulder pad
- Padded handle
- Rain protection hood integrated into the lower part of the back section

00121349	
8	HT



hama

"Phoenix" Camera Bag, 140, black

Material	Recycled Polyester (R-PET)
Inside Dimensions W x D x H	26 x 16.5 x 21 cm
Weight	500 g

- Main compartment with dual-zip opening
- Flat front pocket with 2 mesh compartments for e.g. batteries
- Zipped compartment on the cover
- Additional zip fastener under the cover for e.g. memory cards
- Zipped compartment on the back of the bag
- Pocket on the inside of the back of the bag
- 2 external mesh compartments on the sides
- Flexible, adjustable tripod holders under the mesh pockets on the sides
- 2 variable inner dividers
- Trolley strap on the back
- Wipeable base
- Removable and length-adjustable shoulder strap with ergonomically shaped shoulder pad
- Padded handle
- Rain protection hood integrated into the lower part of the back section

00121350	
8	HT



hama

"Phoenix" Camera Bag, 170, black

Material	Recycled Polyester (R-PET)
Inside Dimensions W x D x H	36 x 22 x 23 cm
Weight	700 g

- Main compartment with dual-zip opening
- Flat front pocket with 3 mesh compartments for e.g. batteries
- Zipped compartment on the cover
- Additional zip fastener under the cover for e.g. memory cards
- Zipped compartment on the back of the bag
- Pocket on the inside of the back of the bag for a tablet
- 2 external mesh compartments on the sides
- Flexible, adjustable tripod holders under the mesh pockets on the sides
- 7 variable inner dividers
- Trolley strap on the back
- Wipeable base
- Removable and length-adjustable shoulder strap with ergonomically shaped shoulder pad
- Padded handle
- Rain protection hood integrated into the lower part of the back section

00121351	
4	HT



hama

"Phoenix" Camera Bag, 200, black

Material	Recycled Polyester (R-PET)
Inside Dimensions W x D x H	38 x 22 x 27 cm
Weight	800 g

- Main compartment with dual-zip opening
- Flat front pocket with 3 mesh compartments for e.g. batteries
- Zipped compartment on the cover
- Additional zip fastener under the cover for e.g. memory cards
- Zipped compartment on the back of the bag
- Pocket on the inside of the back of the bag for a tablet
- 2 external mesh compartments on the sides
- Flexible, adjustable tripod holders under the mesh pockets on the sides
- 7 variable inner dividers
- Trolley strap on the back
- Wipeable base
- Removable and length-adjustable shoulder strap with ergonomically shaped shoulder pad
- Padded handle
- Rain protection hood integrated into the lower part of the back section

00121352	
2	HT



hama

"Samara" Camera Bag, 100, black

Material	Polytex (600D)
Inside Dimensions W x D x H	14.5 x 7.5 x 10.5 cm
Weight	175 g

- Double-zip opening for quick access
- Patch zipped front pocket for accessories
- Length-adjustable shoulder strap
- Handle
- Soft fleece inside lining
- One removable inner divider

Black				00185083
	12	HT		



hama

"Samara" Camera Bag, 110, black

Material	Polytex (600D)
Inside Dimensions W x D x H	16 x 10 x 13 cm
Weight	215 g

- Double-zip opening for quick access
- Patch zipped front pocket for accessories
- Length-adjustable shoulder strap
- Handle
- Soft fleece inside lining
- One removable inner divider

Black				00185086
	8	HT		



hama

"Samara" Camera Bag, 140, black

Material	Polytex (600D)
Inside Dimensions W x D x H	23 x 11 x 16 cm
Weight	300 g

- Double-zip opening for quick access
- Patch zipped front pocket for accessories
- Length-adjustable shoulder strap
- Handle
- Soft fleece inside lining
- One removable inner divider

Black				00185087
	6	HT		



hama

"Terra" Camera Bag, 90, grey

Material	Recycled Polyester (R-PET)
Inside Dimensions W x D x H	8 x 7.5 x 13 cm
Weight	225 g

- The "Terra" range is synonymous with sustainable, high-quality products that are good for both you and the environment
- Both the inner and outer material are made from 100% recycled polyester
- Resource-sparing production from recycled PET materials that can be processed into yarn
- Compartment under the cover for storage media
- Double-zipper opening for easy handling
- Front compartment
- Two side compartments
- Wipeable base
- Detachable shoulder strap
- Belt loop for easy carrying

Grey				00121305
	32	HT		

Photo Bag

EQUIPMENT BAGS



hama

"Terra" Camera Bag, 110, grey

Material	Recycled Polyester (R-PET)
Inside Dimensions W x D x H	15.5 x 10 x 13 cm
Weight	340 g

- The "Terra" range is synonymous with sustainable, high-quality products that are good for both you and the environment
- Both the inner and outer material are made from 100% recycled polyester
- Resource-sparing production from recycled PET materials that can be processed into yarn
- Compartment under the cover for storage media and accessories
- Double-zipper opening for easy handling
- Front compartment with zip fastener
- Two side compartments
- Wipeable base
- Detachable shoulder strap
- Belt loop for easy carrying
- Quick-grab handle
- 1 adjustable inner divider

Grey	00121306
18	HT



hama

"Terra" Camera Bag, 130, grey

Material	Recycled Polyester (R-PET)
Inside Dimensions W x D x H	20 x 10.5 x 16.5 cm
Weight	375 g

- The "Terra" range is synonymous with sustainable, high-quality products that are good for both you and the environment
- Both the inner and outer material are made from 100% recycled polyester
- Resource-sparing production from recycled PET materials that can be processed into yarn
- Compartment under the cover for storage media and accessories
- Double-zipper opening for easy handling
- Front compartment with zip fastener
- Two side compartments
- Wipeable base
- Detachable shoulder strap
- Trolley strap
- Quick-grab handle
- 1 adjustable inner divider

Grey	00121307
8	HT



hama

"Terra" Camera Bag, 135, grey

Material	Recycled Polyester (R-PET)
Inside Dimensions W x D x H	23 x 9.5 x 14 cm
Weight	400 g

- The "Terra" range is synonymous with sustainable, high-quality products that are good for both you and the environment
- Both the inner and outer material are made from 100% recycled polyester
- Resource-sparing production from recycled PET materials that can be processed into yarn
- Compartment under the cover for storage media and accessories
- Double-zipper opening for easy handling
- Front compartment with zip fastener
- Two side compartments
- Wipeable base
- Detachable shoulder strap
- Trolley strap
- Quick-grab handle
- 1 adjustable inner divider

Grey	00121308
8	HT



hama

"Valletta" Camera Bag, 90, black

Material	Polytex
Inside Dimensions W x D x H	9 x 8 x 13 cm
Weight	160 g

- Cover flap with hook and loop fastener
- Additional front compartment with zip fastener
- Detachable shoulder strap
- Belt loop for carrying comfort

Black	00185071
18	HT



hama

"Valletta" Camera Bag, 100, black

Material	Plastic Material, Polyester
Inside Dimensions W x D x H	14.5 x 7.5 x 10.5 cm
Weight	260 g

- Main compartment with zip opening
- Two mesh pockets on the sides
- Additional front compartment with zip fastener
- Two belt loops for comfortable carrying
- Padded handle
- Adjustable inner divider
- Detachable shoulder strap

Black				00185072
	18	HT		



hama

"Valletta" Camera Bag, 110, black

Material	Polytex
Inside Dimensions W x D x H	15.5 x 10 x 13 cm
Weight	310 g

- Main compartment with zip opening
- Two mesh pockets on the sides
- Additional front compartment with zip fastener
- Two belt loops for comfortable carrying
- Padded handle
- Adjustable inner divider
- Detachable shoulder strap

Black				00185073
	16	HT		



hama

"Valletta" Camera Bag, 130, black

Material	Polyester
Inside Dimensions W x D x H	20 x 11 x 17 cm
Weight	390 g

- Main compartment with zip opening
- Two mesh pockets on the sides
- Additional front compartment with zip fastener
- Two belt loops for comfortable carrying
- Padded handle
- Adjustable inner divider
- Detachable shoulder strap

Black				00185074
	8	HT		



hama

"Valletta" Camera Bag, 140, black

Material	Polytex
Inside Dimensions W x D x H	22 x 11.5 x 20.5 cm
Weight	400 g

- Main compartment with zip opening
- Two mesh pockets on the sides
- Additional front compartment with zip fastener
- Two belt loops for comfortable carrying
- Padded handle
- Adjustable inner divider
- Detachable shoulder strap

Black				00185075
	4	HT		

Suitcases

Trolley

PHOTO BACKPACK



"Miami" Camera Trolley, 200, black/red

hama

Material	Nylon
Outside Dimensions W x D x H	30 x 23 x 50 cm
Weight	2900 g

- Padded, removable camera compartment with a lid made of mesh material
- One front compartment with a padded notebook divider
- One additional front compartment each with an organizer and for small accessories
- Tablet compartment made from neoprene material under the lid
- 8 removable inner dividers in the camera compartment, 1 neoprene divider with hook and loop fastener for fixing a camera
- Adjustable length shoulder straps with ergonomic padding integrated in the back of the trolley
- Handle with soft padding
- Two side pockets made of mesh material
- Adjustable tripod holder at the side of the trolley
- Feet
- Trolley frame and wheels
- Suitable as hand luggage
- All-weather cover protects the backpack from rain and dust

200				00139854
		1	HT	



"Ohio" Camera Trolley, 200, Stable Photo Case for Hand Luggage, black/red

hama

Material	Recycled Polyester (R-PET)
Outside Dimensions W x D x H	30 x 23 x 50 cm
Weight	2900 g

- Main compartment with double zip
- Padded, removable camera compartment with cover closure made from mesh material
- One front compartment with padded notebook divider
- One further front compartment with organiser and pockets for small accessories
- Under the cover is a tablet compartment made from neoprene material
- 8 removable inner dividers in the camera compartment, 1 neoprene divider with hook and loop fastener secures the camera in place
- Length-adjustable backpack strap with ergonomically shaped padding, integrated into the back of the trolley
- Soft, padded carrying handle
- Two side pockets made from mesh material
- Height-adjustable tripod holder on the side of the trolley
- Base
- Trolley frame and wheels
- Suitable as hand luggage
- All-weather cover protects the backpack from rain and dust

200				00121347
		1	HT	

Backpack



"Matera" Camera Backpack, 200, black

hama

Material	Recycled Polyester (R-PET)
Width x Height x Depth	31 x 42 cm
Volume	22 l
Weight	900 g

- Quick access to the padded camera compartment via the outside of the backpack
- Compartment that can be filled from the top for personal items, with double zip fastener
- Compartment on the rear with double zip fastener for complete access to the camera gear
- On the inside of the backpack is a compartment for tablets or Notebooks up to 15.6"
- 5 adjustable inner dividers and an elasticated band holder in camera compartment
- Length-adjustable shoulder straps with ergonomically shaped padding
- Padded back
- Adjustable chest strap
- With an additional shoulder strap, the backpack can be converted into a shoulder bag
- Extra carry handle at top and on the side
- 2 compartments with zip fasteners on the front of the backpack
- 1 side pocket (e.g. for water bottle)
- Adjustable loops on the bottom of the backpack for attaching a tripod, etc.
- Suitable as hand luggage
- All-weather cover protects the backpack from rain and dust

39,12 cm (15,4")	00121341
2	HT



"Matera" Camera Backpack, 160, black

hama

Material	Recycled Polyester (R-PET)
Width x Height x Depth	30 x 50 x 17.5 cm
Volume	26 l
Weight	850 g

- Both the inner and outer material are made from 100% recycled polyester
- Resource-sparing production from recycled PET materials that can be processed into yarn
- Padded, removable camera compartment integrated into bottom section
- Camera compartment opening secured with water-repellent zip fastener
- Compartment that can be filled from the top for personal items etc.
- On the inside of the back is a compartment for tablets or Notebooks up to 15.6"
- 5 removable inner dividers in the camera compartment
- Length-adjustable shoulder straps with ergonomically shaped padding
- Padded back section
- Adjustable chest strap
- Extra carry handle
- 2 side pockets (e.g. for water bottle)
- Adjustable loops for attaching a tripod etc.
- Suitable as hand luggage
- All-weather cover protects the backpack from rain and dust

39,12 cm (15,4")	00121340
2	HT

PHOTO BACKPACK

Backpacks

PHOTO BACKPACK



"Miami" Camera Backpack, 190, black/red

hama

Material	Polyester
Volume	12 l
Weight	950 g

- Padded camera compartment
- 8 removable inner dividers in the camera compartment, 1 neoprene divider with hook and loop fastener for fixing a camera
- Adjustable length shoulder straps with ergonomic padding
- Adjustable waist strap
- Handle with soft padding
- Neoprene compartment for tablet PCs up to 10.1" and zippered mesh compartment under the lid
- Additional front compartment with a zippered mesh compartment and an organizer made from neoprene material
- Two side pockets made from mesh material
- Adjustable tripod holder at the side of the backpack
- Suitable for hand luggage
- All-weather cover protects the backpack from rain and dust

25.91 cm [10.2"]	00139855
2	HT



"Miami" Camera Backpack, 150, black/red

hama

Material	Polyester
Volume	5 l
Weight	600 g

- Padded camera compartment
- 8 removable inner dividers in the camera compartment, 1 neoprene divider with hook and loop fastener for fixing a camera
- Adjustable length shoulder straps with ergonomic padding
- Adjustable waist strap
- Handle with soft padding
- Neoprene compartment for tablet PCs up to 10.1" under the lid
- Additional front compartment with a zippered mesh compartment and an organizer made from neoprene material
- Two side pockets made from mesh material
- Adjustable tripod holder at the side of the backpack
- Suitable for hand luggage
- All-weather cover protects the backpack from rain and dust

25.91 cm [10.2"]	00139856
4	HT



"Ohio" Camera Backpack, 190, black/red

hama

Material	Recycled Polyester (R-PET)
Width x Height x Depth	33 x 48 x 20 cm
Volume	12 l
Weight	950 g

- Padded camera compartment with double-zipper opening
- 8 removable inner dividers in the camera compartment, 1 Neoprene divider with hook and loop fastener secures the camera in place
- Length-adjustable shoulder straps with ergonomically shaped padding
- Length-adjustable hip strap
- Length-adjustable breast strap
- Soft, padded carrying handle
- Under the cover is a Neoprene compartment for tablet PCs up to 14.6"
- Further front pocket with mesh zip-up compartment and organiser made from Neoprene material
- Two side pockets made from mesh material
- Height-adjustable tripod holder on the side of the backpack
- Suitable as hand luggage
- All-weather cover protects the backpack from rain and dust

32,77 cm (12,9")	00121346
2	HT

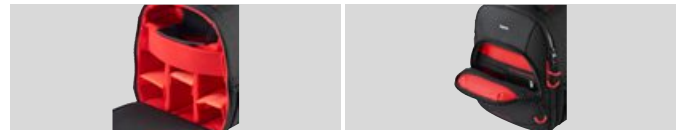

"Ohio" Camera Backpack, 150, black/red

hama

Material	Recycled Polyester (R-PET)
Width x Height x Depth	26 x 37 x 18 cm
Volume	5 l
Weight	600 g

- Padded camera compartment with double-zipper opening
- 6 removable inner dividers in the camera compartment, 1 Neoprene divider with hook and loop fastener secures the camera in place
- Length-adjustable shoulder straps with ergonomically shaped padding
- Length-adjustable hip strap
- Length-adjustable breast strap
- Soft, padded carrying handle
- Under the cover is a Neoprene compartment for tablet PCs up to 10.1"
- Further front pocket with mesh zip-up compartment and organiser made from Neoprene material
- Two side pockets made from mesh material
- Height-adjustable tripod holder on the side of the backpack
- Suitable as hand luggage
- All-weather cover protects the backpack from rain and dust

27,9 cm (11")	00121345
4	HT

Backpacks

PHOTO BACKPACK



"Profitour" Camera Back Pack, 240, black

hama

Material	Nylon
Volume	21 l
Weight	1950 g

- Variable internal sectioning thanks to hook and eye connectors allows a mix of photo equipment and personal items
- Lens support ensures a secure grip for the camera
- It is loaded from the back and in the lower section, protecting the contents from theft
- The back pack is divided into two separate photo sections
- Two large side pockets with zip fasteners
- One elastic side pocket
- Padded tablet pocket on the inside of the back
- 1 mesh inner pocket for further accessories
- The internal compartments for full / spent batteries and filters
- Internal compartments for full / empty memory cards directly on the quick access
- 1 zipped compartment under the cover
- 1 zipped compartment on the cover
- Padded, length-adjustable shoulder strap and abdominal belt
- Zipped compartments on the right and left of the abdominal belt
- Soft, padded back section
- Soft handle
- Height-adjustable breast strap with signal piping
- Loop with fastener at the top and stowable small bag at the bottom for secure tripod transport
- Holders on the right and left, with two loops at the bottom for attaching hiking sticks, etc.
- Integrated rain hood
- Suitable as hand luggage

25.91 cm [10.2"]	00139842
2	HT



"Profitour" Camera Backpack, 180, black

hama

Material	Nylon
Volume	15 l
Weight	1350 g

- Inner dividers adjustable by means of hook and loop fasteners, allow accommodation of photographic equipment and personal items
- Lens support provides a secure hold for the camera
- The backpack can be filled from the back, the contents are thus protected from theft
- Two large elastic side pockets
- Padded inner compartment for a tablet PC (on the back)
- 2 mesh compartments (inside) for additional accessories
- Three inner compartments for full/empty batteries and filters
- Inner compartments for full/empty memory cards directly at the quick access opening
- 1 zipped compartment under the lid
- 1 zipped compartment on the lid
- Padded, adjustable shoulder straps and lap belts
- Back with soft padding
- Soft handle
- Adjustable chest strap with signal whistle
- Loop with a fastener at the top and stowable small bag below for safe transportation of a tripod
- Holders on the left and right, two loops for attaching walking sticks and more at the bottom
- Integrated rain cover
- Suitable for hand luggage

25.91 cm [10.2"]	00139841
2	HT



"Samara" Camera Backpack, 170, black

hama

Material	Polytex (600D)
Volume	8 l
Weight	390 g

- Padded camera compartment with double-zipper opening
- 7 removable inner dividers in the camera compartment
- Length-adjustable shoulder strap
- Handle
- Under the cover is a zipped compartment for further accessories
- Two side pockets made from mesh material
- Tripod holder on the side of the backpack

		00185088	
	3	HT	



"Terra" Camera Backpack, 140, grey

hama

Material	Recycled Polyester (R-PET)
Width x Height x Depth	27 x 42 x 23 cm
Volume	13 l
Weight	750 g

- The "Terra" range is synonymous with sustainable, high-quality products that are good for both you and the environment
- Both the inner and outer material are made from 100% recycled polyester
- Resource-sparing production from recycled PET materials that can be processed into yarn
- Quick access to the padded camera compartment via the outside of the backpack
- Compartment that can be filled from the top for personal items, etc.
- On the inside of the back is a compartment for tablet PCs up to 12.9"
- 1 removable inner divider in the camera compartment
- 1 removable inner divider in the main compartment
- Length-adjustable shoulder straps with ergonomically shaped padding
- Ergonomically padded back section made from mesh material
- Adjustable chest strap
- Special handle on the back at the top
- Additional handle on the side
- On the inside, under the cover, there are two compartments for accessories such as batteries and SD cards
- A zip pocket on the front with internal compartments for cards and pens
- A width-adjustable side pocket for tripods or water bottles
- Adjustable loop for attaching a tripod, etc.
- Suitable as hand luggage
- Trolley strap on the back
- All-weather cover protects the backpack from rain and dust
- Wipeable base

32,77 cm (12,9")		00121309	
	2	HT	

PHOTO BACKPACK

ActionCam-/GoPro Accessories



Straps and hand straps | Monopods & Tripods

ACTIONCAM-GOPRO ACCESSORIES

Carrying Strap



hama

Chest Mount for GoPro

Shade of colour	Black
Material	Nylon

- Can be put on quickly, allows easy attachment of the camera and ensures a secure hold in action
- Simply engage the camera on the quick-release fastener
- Allows you to take stunning videos and photos while wearing your camera on your chest, both hands remain free
- Sturdy quick-release fastener
- Elastic stretch material
- With a transport bag for protecting the equipment

00004358	
6	BK

Hand Strap



hama

"2in1" Floaty Grip, black

Material	Plastic Material
----------	------------------

- The floaty grip prevents the GoPro action camera or underwater camera from going down in water
- Suitable for GoPro action cameras and underwater cameras with 1/4" screwed connection
- Single hand grip and buoyancy aid in one
- Slip-resistant grip

Black	00004458
6	HB



hama

Floaty Grip for GoPro, yellow

Material	Plastic Material
----------	------------------

- The floaty grip prevents the GoPro action camera from going down in water
- Single hand grip and buoyancy aid in one
- Bright yellow signal colour for quickly finding it again
- Adjustable hand strap for securing the camera

Yellow	00004407
6	BK

Tripod



hama

"Traveller Pro" Tripod for Smartphones, GoPros, Photo Cameras, 105 - Ball

Thread/Connection	1/4" (6.4 mm), GoPro, Smartphone holder
Leg Segments	8 Sections (7x Extendible)
Material	Aluminium
Maximum Load	500 g
Tripod Head	Ball Head
Type	Tripod
Min. Height - Max. Height	23 -105 cm
Maximum Profile Thickness	19 mm
Weight	455 g

- Its compact size makes it ideal for travelling, holidays, hikes and outdoor trips
- Sensational, versatile photos and videos from original perspectives and unusual places
- For selfies and videos, perfect for video diaries, blogs and ideal for travel and out and about
- No more wobbly, skewed selfies
- Tripod leg covered with high-quality, durable rubber with a honeycomb pattern for outstanding grip
- Rotary ring on the tripod head allows a wide or narrow spread of the tripod legs depending on the setting
- Extremely flexible, suitable for a smartphone width from 4.8 – 9.5 cm (in horizontal format) thanks to the double extendable clamp spring holder
- Foam padding on the holder protects the smartphone case from scratches
- Patterned rubber feet for firm grip on smooth, slippery and uneven surfaces
- Space-saving design: the smartphone holder can be folded

Red	00004620
6	HB



hama

"Traveller Pro" Tripod for Smartphones, GoPros, Photo Cameras, 106 - 2D

Thread/Connection	1/4" (6.4 mm), GoPro, Smartphone holder
Leg Segments	8 Sections (7x Extendible)
Material	Aluminium
Maximum Load	500 g
Tripod Head	2D: 2-Way Head
Type	Tripod
Min. Height - Max. Height	25.5 -106 cm
Maximum Profile Thickness	19 mm
Weight	610 g

- the 2D tilt head allows perfect alignment for landscape shots
- Its compact size makes it ideal for travelling, holidays, hikes and outdoor trips
- Sensational, versatile photos and videos from original perspectives and in unusual locations
- For selfie photos and videos, ideal for video diaries, blogs and for holidays and life on the move
- No more wobbly, skewed selfies
- Tripod leg covered with high-quality, durable rubber with a honeycomb pattern for outstanding grip
- Rotary ring on the tripod head allows a wide or narrow spread of the tripod legs depending on the setting
- Extremely flexible, suitable for a smartphone width from 4.8 – 9.5 cm (in horizontal format) thanks to the double extendable clamp spring holder
- Foam padding on the holder protects the smartphone case from scratches
- Patterned rubber feet for firm grip on smooth, slippery and uneven surfaces

Red	00004631
20	HB

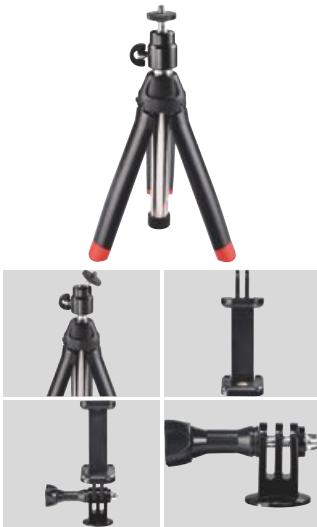

hama

"Multi 4in1" Table Tripod

Thread/Connection	1/4" (6.4 mm)
Leg Segments	1 Section
Material	Aluminium
Maximum Load	400 g
Tripod Head	3-Way Head
Type	Tripod
Min. Height - Max. Height	19 -86 cm
Weight	220 g

- The ball head allows perfect alignment for shots in portrait and landscape format
- Its compact size makes it ideal for travelling, holidays, hikes and outdoor trips
- The built-in self monopod is ideal for sports and action shots e.g. for filming yourself when skiing
- Selfie Stick / Telescopic Rod:
- Telescopic rod extendable to 90 cm for a wide range of action, for e.g. concert recordings, hard-to-reach motifs and group shots
- Torsion-resistant telescopic rod through guide groove
- Min/max height: 20/90 cm
- Weight: 225 g

Smartphone Holder:

- Extremely flexible, for a smartphone width from 5.5 - 7.8 cm (in horizontal format)
- For selfies and videos, perfect for video diaries, blogs and ideal for travel and out and about
- Also in combination with tripods and telescopic rods with 1/4" connection thread

Black				6	SC	00004601
-------	--	--	--	---	----	----------



hama

Tripod "Flex for Smartphone and GoPro, 14 cm"

Thread/Connection	GoPro, Smartphone holder
Leg Segments	1 Section
Material	Aluminium
Maximum Load	4000 g
Tripod Head	No
Type	Bendable Tripod
Min. Height - Max. Height	7 -14 cm
Maximum Profile Thickness	26 mm
Weight	70 g

- The flexible legs are capable of bending up to 360° which allows optimal, secure attachment to various objects, e.g. railings, branches
- 2-in-1 system for smartphones and GoPro cameras
- Its compact size makes it ideal for travelling, holidays, hikes and outdoor trips
- Sensational, versatile photos and videos from original perspectives and unusual places
- Stepless, individually bendable tripod legs — adaptable to many surfaces and objects and can be used as a hand-held tripod
- For selfies and videos, perfect for video diaries, blogs and ideal for travel and out and about
- No more wobbly, skewed selfies
- Tripod legs encased in high quality foam for maximum flexibility and grip, making them especially pleasant to use in cold weather

Red						00004611
Black				6	HB	00004609



hama

Tripod "Flex for Smartphone and GoPro, 26 cm"

Thread/Connection	GoPro, Smartphone holder
Leg Segments	1 Section
Material	Aluminium
Maximum Load	300 g
Tripod Head	No
Type	Bendable Tripod
Min. Height - Max. Height	9 -26 cm
Weight	145 g

- The flexible legs are capable of bending up to 360° which allows optimal, secure attachment to various objects, e.g. railings, branches
- 2-in-1 system for smartphones and GoPro cameras
- Its compact size makes it ideal for travelling, holidays, hikes and outdoor trips
- Sensational, versatile photos and videos from original perspectives and unusual places
- Stepless, individually bendable tripod legs — adaptable to many surfaces and objects and can be used as a monopod
- For selfies and videos, perfect for video diaries, blogs and ideal for travel and out and about
- No more wobbly, skewed selfies
- Tripod legs encased in high quality foam for maximum flexibility and grip, making them especially pleasant to use in cold weather
- Extremely flexible, suitable for a smartphone width from 5.5 – 7.8 cm (in horizontal format) thanks to the clamp spring holder

Blue						00004615
Black				6	HB	00004613

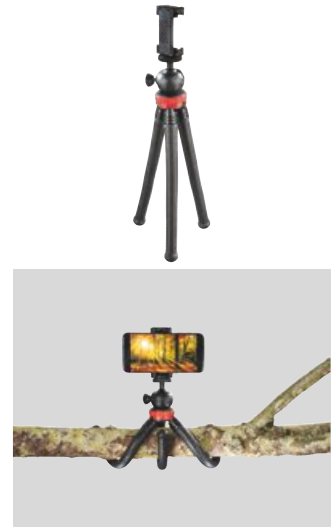

hama

Tripod „FlexPro for Smartphone, GoPro and photocameras, 27 cm“

Thread/Connection	1/4" (6.4 mm), 3D, Ball, GoPro, Smartphone holder
Leg Segments	1 Section
Material	Aluminium/Rubber
Maximum Load	300 g
Tripod Head	Ball Head
Type	Bendable Tripod
Min. Height - Max. Height	16 -27 cm
Maximum Profile Thickness	26 mm
Weight	348 g

- The flexible legs are capable of bending up to 360° which allows optimal, secure attachment to various objects, e.g. railings, branches
- 3-in-1 system for smartphones, GoPro cameras and ¼-inch thread
- The ball head allows perfect alignment for shots in portrait and landscape format
- Its compact size makes it ideal for travelling, holidays, hikes and outdoor trips
- Sensational, versatile photos and videos from original perspectives and unusual places
- Stepless, individually bendable tripod legs — adaptable to many surfaces and objects and can be used as a monopod
- For selfies and videos, perfect for video diaries, blogs and ideal for travel and out and about
- No more wobbly, skewed selfies
- Tripod legs covered with high-quality, durable rubber with a honeycomb pattern for maximum flexibility and outstanding grip

Red						00004608
Black				6	HB	00004605

Monopods & Tripods | Holders

ACTIONCAM-GOPRO ACCESSORIES

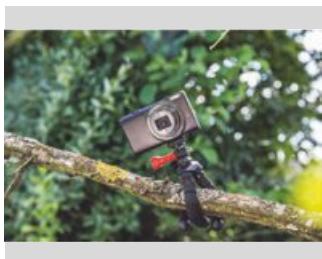

hama

"Flex 2in1" Mini-Tripod for Photo Cameras and GoPro, 14 cm

Thread/Connection	1/4" (6.4 mm), GoPro
Leg Segments	1 Section
Material	Aluminium
Maximum Load	300 g
Tripod Head	No
Type	Bendable Tripod
Min. Height - Max. Height	7.5 -14 cm
Weight	64 g

- The flexible legs are capable of bending up to 360° which allows optimal, secure attachment to various objects, e.g. railings, branches
- 2in1 system for 1/4 inch threads and GoPro cameras
- Its compact size makes it ideal for travelling, holidays, hikes and outdoor trips
- Non-slip foam on the tripod legs
- Can of course also be used as a normal table tripod

Black				00004557
	6	HB		



hama

Suction Mount with Ball Head 360 for GoPro

Thread/Connection	1/4" (6.4 mm), GoPro
Leg Segments	1 Section
Material	Plastic Material
Maximum Load	300 g
Tripod Head	3D Ball Head
Type	Suction Stand
Min. Height - Max. Height	5 -11 cm
Weight	180 g

- The ball head allows perfect alignment for shots in portrait and landscape format
- For GoPro action cameras and digital cameras with a 1/4" connection thread
- 3D ball head with 360° rotation
- Can also be used as a car pod
- Diameter of the suction cup: 90 mm
- Thread length adjustable, therefore universally usable

Black				00004356
	6	BK		

Selfie Stick

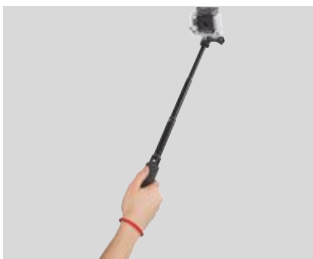

hama

"Selfie 90" Self-Monopod

Maximum Length	90 cm
Minimum Length	30 cm

- 2in1 system for 1/4 inch threads and GoPro cameras
- The telescopic pole is extendable up to 90 cm and ideal for situations where additional height is necessary to capture the desired images, e.g. at action recordings, concerts, for difficult-to-capture subjects or group pictures
- Completely new perspectives are possible with this self monopod
- Connection for all cameras with a tripod thread, e.g. action cameras or digital cameras and GoPro connection
- Non-slip foam grip with a hand strap and snap hook for a firm and secure grip
- Can also be used as a tripod extension

Black				00004299
	6	BK		

Holder



hama

Head Strap Mount for GoPro

Attachment	Strap Attachment
Material	Nylon

- Non-slip rubber coating on the inside for a firm hold
- Gives you a near-eye level point of view by securely fitting around your ski and sports helmets, both hands remain free
- The strap can be worn directly on your head or over a helmet
- Fully adjustable to fit different sizes
- Elastic stretch material

Black				00004359
	6	BK		



hama

"Side" Helmet Mount for GoPro

Attachment	Adhesive Mounting
Material	Plastic Material

- 3-way swivelling arm for all imaginable shooting angles
- The high-quality 3M adhesive technology ensures a consistently reliable hold also in the rain and cold
- Gives you a near-eye level point of view by securely fitting around your ski and sports helmets, both hands remain free

Black				00004396
	12	BK		



hama

"Front" Helmet Mount for GoPro

Attachment	Adhesive Mounting
Material	Plastic Material

- The high-quality 3M adhesive technology ensures a consistently reliable hold also in the rain and cold
- Gives you a near-eye level point of view by securely fitting around your ski and sports helmets, both hands remain free
- Allows you to capture forward facing footage by mounting your GoPro action camera on the helmet

Black	00004398	
	12	BK



hama

"Large" Pole Mount for GoPro, from 2.5 - 6.2 cm

Attachment	Pole Mount
Material	Plastic Material

- 3-way swivelling arm for all imaginable shooting angles
- Extraordinary perspectives on handlebars, rods, ski poles, etc., both hands remain free
- Suitable for rods and tubes from 2.5 to 6.2 cm

Black	00004399	
	12	BK



hama

1/4" Camera Connection Adapter for GoPro Accessories, Version II

Material	Plastic Material
----------	------------------

- 3-way swivelling arm for all imaginable shooting angles
- The high-quality 3M adhesive technology ensures a consistently reliable hold also in the rain and cold
- Set comprising two different adhesive mounts, two different quick-release fasteners, one 3-way swivelling arm and one long replacement screw

Black	00004467	
	12	BK

Accessories Set



hama

Accessory Set for GoPro

Set Contents in Pieces	11
------------------------	----

- 3-way swivelling arm for all imaginable shooting angles
- The high-quality 3M adhesive technology ensures a consistently reliable hold also in the rain and cold
- Set comprising two different adhesive mounts, two different quick-release fasteners, one 3-way swivelling arm and one long replacement screw

Adhesive pads

	00004397	
	12	BK



hama

Mounting Clamp, 360°, for GoPro

Attachment	Clamp for fixing
Material	Plastic Material

- Allows ultra compact and space-saving attachment
- Can be rotated 360°
- For attaching to jackets, rods, plates, glass and much more
- Small teeth on the inside of the clamp for a firm grip

Black	00004395	
	12	BK



hama

"Small" Pole Mount for GoPro, from 1.6 - 4 cm

Attachment	Pole Mount
Material	Plastic Material

- 3-way swivelling arm for all imaginable shooting angles
- Extraordinary perspectives on handlebars, rods, ski poles, etc., both hands remain free
- Suitable for rods and tubes from 1.6 to 4.0 cm

Black	00004375	
	12	BK



hama

Camera Adapter for GoPro to 1/4" Tripod Mount

Material	Plastic Material
----------	------------------

- The high-quality 3M adhesive technology ensures a consistently reliable hold also in the rain and cold
- 4-part replacement set consisting of two straight (e.g. for car windows) and two curved (e.g. for sports helmets, handlebars) adhesive mounts
- If required the adhesive mounts can be cleanly removed when heat (hair-dryer) is applied

Black	00004354	
	12	BK



hama

Adhesive Mount Set for GoPro

Set Contents in Pieces	4
------------------------	---

- The high-quality 3M adhesive technology ensures a consistently reliable hold also in the rain and cold
- 4-part replacement set consisting of two straight (e.g. for car windows) and two curved (e.g. for sports helmets, handlebars) adhesive mounts
- If required the adhesive mounts can be cleanly removed when heat (hair-dryer) is applied

	00004374	
	12	BK

Smartphone/Tablet- Photo Accessories



Lights, changeable

SMARTPHONE/TABLET PHOTO ACCESSORIES



"SpotLight Steady 120 II" LED Ring Light, Ring Light Tripod for Mobile Phone, 12"

hama

- From influencer to video star: the set, comprising an LED ring light and tripod for the ideal height, offers the ideal conditions for every content creator, and is perfect for all online formats, including YouTube, Twitch, Instagram, TikTok and more
- Selfie ring light with mobile phone holder: The flexible clamping jaws hold the smartphone camera perfectly in position on the tripod, so one tripod is enough for both the phone and ring light
- Small when transporting, big effect when filming: the LED ring light with tripod can be set up quick as a flash anywhere, making it perfect for blogs, vlogs, social media and anyone who likes their equipment flexible and practical
- In your best light: the tripod ring light with 160 LEDs creates the ideal lighting for all video and image formats, so there's less post-editing and instead great images and videos from the first take
- From warm white to daylight bright: control the colour temperature in 3 stages (2100/3000/5500 K) using the cabled remote control, for the optimised and even illumination of videos

- and portraits, for example
- From radiantly bright to pleasantly dimmed: the light intensity can be adjusted in 10 stages
- Sparkling charming eye effect: LED ring light magically creates a light in the eyes through reflections
- Studio smartphone photography: stable tripod made from robust and lightweight aluminium with fully spreadable tripod legs
- Up and away: extendable 3 ways up to 215 cm, ideal for larger scenarios or for being photographed sitting or standing
- Always the perfect recording position: portrait and landscape format thanks to smartphone holder with ball head and flexible swan neck
- Unusual recording angle: the ring light position can be adjusted in all directions thanks to the ball head
- Universal stand for shots in portrait or landscape format, be it selfies, portraits or video, DIY tutorials or Insta-Live

Black				00004659
	4	SC		

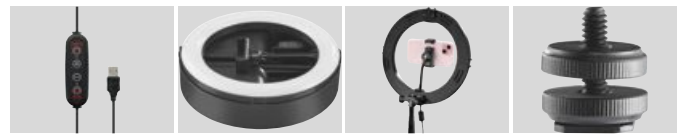

"SpotLight FoldUp RGB 102" LED-RGB Ring Light, Smartphone Kit, Folding

hama

- Colourful play of colours: switch on RGB mode on the LED ring light and play with 29 colour options including dynamic effects - for a unique ambience on shoots, live streams and video
- Sparkling charming eye effect: LED ring light magically creates a light in the eyes through reflections
- From warm white to daylight bright: control the colour temperature in 3 stages using the cabled remote control, for the optimised and even illumination of videos and portraits, for example
- From radiantly bright to pleasantly dimmed: Light intensity can be adjusted in 9 or 8 stages in RGB mode
- Photo studio to go: the ring light can be folded together and stored in the stand - perfect for all bloggers and vloggers who are on the go a lot
- Up and away: extendable up to 138 cm, ideal for larger scenarios or for being photographed sitting or standing
- Optimised illumination during make-up tutorials or selfie portraits: can also be used as a table tripod at its minimum height of 52 cm
- Always the perfect recording position: portrait and landscape format thanks

- to smartphone holder with ball head and flexible swan neck
- One ring light - three ¼" connection options: all connections with ¼" in one place for e.g. swan neck accessories, smartphones, adapter screws
- One right light - four cold shoe connection options: the cold shoe connections are located on all sides for professional and creative photos and videos with further accessories, e.g. microphone, webcam
- LED-RGB ring light:
- Ring light with 10.2" (external diameter 26.5 cm) and 64 cool white LEDs, 64 warm white LEDs and 30 RGB LEDs with cable remote control
- Power supply via USB-A cable (cable length 190 cm) for connection to e.g. a power pack
- Unusual recording angle: The ring light can be steplessly tilted backward
- Easy-carry construction made from aluminium and plastic

				00004665
	10	SC		

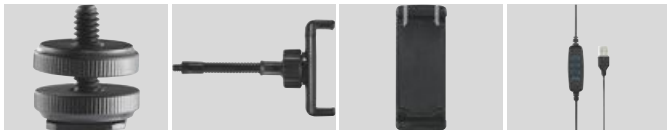

"SpotLight FoldUp 102 II" LED Ring Light, Set for Smartphones, Foldable

hama

- Sparkling charming eye effect: LED ring light magically creates a light in the eyes through reflections
- From warm white to daylight bright: control the colour temperature in 3 stages using the cabled remote control, for the optimised and even illumination of videos and portraits, for example
- From radiantly bright to pleasantly dimmed: the light intensity can be adjusted in 10 stages
- Photo studio to go: the ring light can be folded together and stored in the stand - perfect for all bloggers and vloggers who are on the go a lot
- Up and away: extendable up to 138 cm, ideal for larger scenarios or for being photographed sitting or standing
- Optimised illumination during make-up tutorials or selfie portraits: can also be used as a table tripod at its minimum height of 52 cm
- Always the perfect recording position: portrait and landscape format thanks to smartphone holder with ball head and flexible swan neck
- One ring light - three ¼" connection options: all connections with ¼" in one place for e.g. swan neck accesso-

- ries, smartphones, adapter screws
- One right light - four cold shoe connection options: the cold shoe connections are located on all sides for professional and creative photos and videos with further accessories, e.g. microphone, webcam
- LED Ring Light:
 - 10.2" ring light (outer diameter 26.5 cm) with 128 LEDs with cable remote control
 - Power supply via USB-A cable (cable length 190 cm) for connection to e.g. a power pack
 - Unusual recording angle: The ring light can be steplessly tilted backward
 - Easy-carry construction made from aluminium and plastic
- Swan neck with mobile phone holder:
 - For many smartphones: extremely flexible for smartphone widths from 6.0 to 8.0 cm thanks to clamping spring holder
 - Rubber inserts on the holder protect the smartphone casing from scratches
 - Outer flash shoe holder on the LED ring light

Black			00004658
	10	SC	

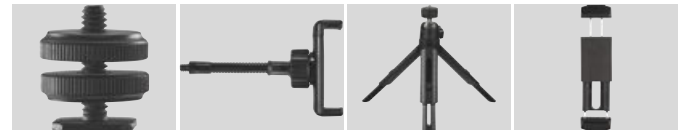

"SpotLight Smart 80 II" LED Ring Light, Set for Smartphones

hama

- Sparkling charming eye effect: LED ring light magically creates a light in the eyes through reflections
- From warm white to daylight bright: control the colour temperature in 3 stages using the cabled remote control, for the optimised and even illumination of videos and portraits, for example
- From radiantly bright to pleasantly dimmed: the light intensity can be adjusted in 10 stages
- Unusual recording angle: ring light can be pivoted and tilted thanks to the tripod ball head
- Always the perfect recording position: portrait and landscape format thanks to smartphone holder with ball head and flexible swan neck
- One ring light - two ¼" connection options: the connections are located at the top and bottom for the perfect combination and positioning of equipment such as a webcam and microphone
- One right light - four cold shoe connection options: the cold shoe connections are located on all sides for professional and creative photos and videos with further accessories, e.g. microphone, webcam

- LED Ring Light:
 - 8" ring light (outer diameter 21 cm) with 96 LEDs with cable remote control
 - Power supply via USB-A cable (cable length 190 cm) for connection to e.g. a power pack
- Swan neck with mobile phone holder:
 - For many smartphones: extremely flexible for smartphone widths from 6.0 to 8.0 cm thanks to clamping spring holder
 - Rubber inserts on the holder protect the smartphone casing from scratches
- Ring light with tripod:
 - Height-adjustable desktop tripod from 13.50 cm to 17.50 cm
 - Tripod legs can be adjusted individually in 4 stages in order to adapt the tripod perfectly to different surfaces
 - Rubber feet for firm grip on smooth, slippery and uneven surfaces
 - Can also be used as a selfie monopod: ideal for selfies, video diaries and blogs

			00004657
	12	HB	

Luminaires | Monopods & Tripods

SMARTPHONE/TABLET PHOTO ACCESSORIES



"49 BD" LED Lights for Smartphone, Photo and Video Cameras

hama

Light Colour	Daylight (approx. 6000K)
Height	8 mm

- LED Lights
- Ultra-lightweight, stylish surface lights with 49 high-end LEDs for shadow-free image lighting during video and photo shots on a smartphone or camera, as well as close-up and macro-photography
- Optimised illumination ensures even, shadow-free pictures
- For digital video and photo cameras with a standard flash shoe
- Attachment to the camera's standard flash shoe and to a tripod using the integrated 1/4" thread
- With dimmer control
- With integrated 1/4" (6.4 mm) connecting thread for external light positioning on a tripod
- Perfect light source for bloggers and vloggers, ideal for life on the move
- Straightforward operation, no complicated studio equipment required
- For sharp, clear and detail-rich shots
- Great photos even in unfavourable lighting
- No charging required, works with two AA batteries
- Multiple LED lights can also be con-

nected together

Smartphone Holder:

- Screw-connected universal holder for devices without tripod socket
- For attaching all smartphones to tripods with a 1/4" tripod connection
- Extremely flexible, for a smartphone width from 4.8 - 9.5 cm (landscape format)
- Cold shoe for attaching LED lights and microphones, for example
- Folds to a compact size
- Only in combination with tripods or telescopic rods featuring a 1/4" connection thread, Arca Swiss
- Clamp spring holder and recess on the surface ensure a firm grip, while rubber protects the housing from scratches

Black				00004641
	16	HB		

Tripod



hama

Tripod for Smartphone/Tablet, 106 - 3D

Thread/Connection	1/4" (6.4 mm), Smartphone holder, Tablet holder
Leg Segments	4 Sections (3x Extendible)
Material	Aluminium
Maximum Load	500 g
Tripod Head	3D: 3-Way Head
Type	Tripod
Min. Height - Max. Height	36,5 -106 cm
Maximum Profile Thickness	16.8 mm
Weight	520 g

- Camera Tripod:
- Camera tripod for blur-free images and stability on uneven surfaces
- 3D: 3-way head allows perfect orientation for level, horizontal and portrait-format snaps
- Quick-change plate for rapid changing of the camera
- Spirit level integrated into the tripod head
- Infinite height adjustment of the central pillar
- Cross-struts and rubber feet for secure stand
- Functional quick-action leg locks for fast and simple locking of the leg length in any position

Smartphone / Tablet Holder:

- with this holder, all smartphones and tablets can be attached to tripod
- Screw-connected universal holder for devices without tripod socket
- Extremely flexible for a smartphone width from 5.5 to 8.2 cm and a tablet width from 11.2 to 18.5 cm (in horizontal format)

Champagne				00004619
	20	SC		



hama

"Star Smartphone" mobile phone tripod, photo travel tripod, ultra-lightweig

Thread/Connection	1/4" (6.4 mm), Smartphone holder
Leg Segments	3 Sections (2x Extendible)
Material	Aluminium
Maximum Load	4000 g
Tripod Head	3-Way Head
Type	Tripod
Min. Height - Max. Height	40 -112 cm
Maximum Profile Thickness	17 mm
Weight	480 g

- From influencer to video star: the camera and mobile phone tripod for the ideal height and accessory mounting offers the ideal conditions for every content creator, and is perfect for all online formats, including YouTube, Twitch, Instagram, TikTok and more
- Ultra-light: The aluminium travel tripod, including 3-way tilt and mobile phone holder weighs just 0.48 kg so you can always bring it with you – capture every moment perfectly, anywhere
- Small and handy mobile phone and camera tripod: The travel tripod with small packed dimensions of just 42 cm is easy to transport and store – compact camera tripod for on the go
- Be on the safe side: the lightweight aluminium tripod can reliably and stably carry up to 4 kg – including camera or smartphone with holder, microphone or light

Black				00004640
	15	SC		



hama

"Traveller Pro" Tripod for Smartphones, GoPros, Photo Cameras, 105 - Ball

Thread/Connection	1/4" (6.4 mm), GoPro, Smartphone holder
Leg Segments	8 Sections (7x Extendible)
Material	Aluminium
Maximum Load	500 g
Tripod Head	Ball Head
Type	Tripod
Min. Height - Max. Height	23 -105 cm
Maximum Profile Thickness	19 mm
Weight	455 g

- Its compact size makes it ideal for travelling, holidays, hikes and outdoor trips
- Sensational, versatile photos and videos from original perspectives and unusual places
- For selfies and videos, perfect for video diaries, blogs and ideal for travel and out and about
- No more wobbly, skewed selfies
- Tripod leg covered with high-quality, durable rubber with a honeycomb pattern for outstanding grip
- Rotary ring on the tripod head allows a wide or narrow spread of the tripod legs depending on the setting
- Extremely flexible, suitable for a smartphone width from 4.8 – 9.5 cm (in horizontal format) thanks to the double extendable clamp spring holder
- Foam padding on the holder protects the smartphone case from scratches
- Patterned rubber feet for firm grip on smooth, slippery and uneven surfaces
- Space-saving design: the smartphone holder can be folded

Red				00004620
	6	HB		



hama

"Traveller Pro" Tripod for Smartphones, GoPros, Photo Cameras, 106 - 2D

Thread/Connection	1/4" (6.4 mm), GoPro, Smartphone holder
Leg Segments	8 Sections (7x Extendible)
Material	Aluminium
Maximum Load	500 g
Tripod Head	2D: 2-Way Head
Type	Tripod
Min. Height - Max. Height	25.5 -106 cm
Maximum Profile Thickness	19 mm
Weight	610 g

- the 2D tilt head allows perfect alignment for landscape shots
- Its compact size makes it ideal for travelling, holidays, hikes and outdoor trips
- Sensational, versatile photos and videos from original perspectives and in unusual locations
- For selfie photos and videos, ideal for video diaries, blogs and for holidays and life on the move
- No more wobbly, skewed selfies
- Tripod leg covered with high-quality, durable rubber with a honeycomb pattern for outstanding grip
- Rotary ring on the tripod head allows a wide or narrow spread of the tripod legs depending on the setting
- Extremely flexible, suitable for a smartphone width from 4.8 – 9.5 cm (in horizontal format) thanks to the double extendable clamp spring holder
- Foam padding on the holder protects the smartphone case from scratches
- Patterned rubber feet for firm grip on smooth, slippery and uneven surfaces

Red				00004631
	20	HB		



hama

"Multi 4in1" Table Tripod

Thread/Connection	1/4" (6.4 mm)
Leg Segments	1 Section
Material	Aluminium
Maximum Load	400 g
Tripod Head	3-Way Head
Type	Tripod
Min. Height - Max. Height	19 -86 cm
Weight	220 g

- The ball head allows perfect alignment for shots in portrait and landscape format
- Its compact size makes it ideal for travelling, holidays, hikes and outdoor trips
- The built-in self monopod is ideal for sports and action shots e.g. for filming yourself when skiing
- Telescopic rod extendable to 90 cm for a wide range of action, for e.g. concert recordings, hard-to-reach motifs and group shots
- Torsion-resistant telescopic rod through guide groove
- Min/max height: 20/90 cm
- Weight: 225 g

- Smartphone Holder:
- Extremely flexible, for a smartphone width from 5.5 - 7.8 cm (in horizontal format)
 - For selfies and videos, perfect for video diaries, blogs and ideal for travel and out and about
 - Also in combination with tripods and telescopic rods with 1/4" connection thread

Black				00004601
	6	SC		



hama

"Rotary Smartphone" 150 Tripod, Set with Bluetooth® Remote Shutter Release

Thread/Connection	1/4" (6.4 mm)
Leg Segments	3 Sections (2x Extendible)
Material	Aluminium
Maximum Load	1000 g
Tripod Head	No
Type	Tripod
Min. Height - Max. Height	41.5 -150 cm
Maximum Profile Thickness	20 mm
Weight	1850 g

- Flexible alternative to large tripods: ideal when things need to move quickly or when there isn't enough space for a large tripod, for example
- Its compact size makes it ideal for travelling, holidays, hikes and outdoor trips
- With the combination of the tripod and holder, take blur-free photographs with the smartphone
- Can be used completely folded up as a selfie monopod
- Stepless height adjustment thanks to telescope mechanism
- Cross-struts and rubber feet for firm grip on smooth, slippery and uneven surfaces
- Swivel smartphone holder for portrait and landscape format
- Extremely flexible, for smartphone width of 5.8 - 8.8 cm
- Compact design
- For selfies and videos, perfect for video diaries, blogs and ideal for out and about

Black				00004646
	20	HB		

Monopods & Tripods

SMARTPHONE/TABLET PHOTO ACCESSORIES



hama

"Star 153 3D" Tripod for Camera and Smartphone, with 3D Tilt

Thread/Connection	1/4" (6.4 mm)
Leg Segments	3 Sections (2x Extendible)
Material	Aluminium
Maximum Load	3000 g
Tripod Head	3-Way Head
Type	Tripod
Min. Height - Max. Height	58 -153 cm
Maximum Profile Thickness	20 mm
Weight	990 g

- From influencer to video star: the camera and mobile phone tripod for the ideal height and accessory mounting offers the ideal conditions for every content creator, and is perfect for all online formats, including YouTube, Twitch, Instagram, TikTok and more
- One tripod, many possibilities: flexible photography and filming with a smartphone, digital camera and video camera
- The 3D tilt head allows perfect alignment for landscape and portrait shots
- Quick-change plate for rapid changing of the camera
- Spirit level at the base
- With crank for stepless height adjustment of the central column
- Fixable cross-struts and flexible rubber feet for secure positioning on uneven surfaces
- Functional quick-action leg locks for fast and simple locking of the leg length in any position
- Carrying handle

Black				00004667
	10	SC		

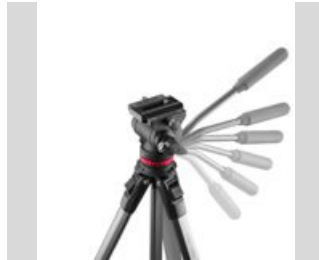

hama

"PRO Move 160 2D+" Tripod, Video Tripod for Camera and Mobile Phone, 160 cm

Thread/Connection	1/4" (6.4 mm), Smartphone holder
Leg Segments	4 Sections (3x Extendible)
Material	Aluminium
Maximum Load	7000 g
Tripod Head	2D Fluid Tripod Head
Type	Tripod
Min. Height - Max. Height	50 -160 cm
Maximum Profile Thickness	29 mm
Weight	1400 g

- Ideal for recording video: the integrated 2D fluid tilt with panorama function guarantees smooth, judder-free panning for perfect shots
- The video tripod incl. 2D fluid tilt and mobile phone holder weighs just 1.6 kg and is always to hand - capture every moment perfectly anywhere
- Safety first: the lightweight photo tripod can stably and reliably hold up to 7 kg – including camera or smartphone with mount, microphone or light as well as a safety weight on the central column
- Flexible tripod for mobile phone and camera: practical mobile phone holder for smartphone included, which makes it all the more faster to change to the mobile phone camera and back – universal tripod for all situations
- Changed out in no time: Quick-change plate for rapid changing of the camera, whether a smartphone, camera, SLR or system camera – always the right device for any setting

Anthracite				00004668
	10	SC		



hama

„Solid" tripod for mobile phone and camera, travel tripod with ball head, max. 19 cm

Thread/Connection	1/4" (6.4 mm), Smartphone holder
Material	Plastic Material
Maximum Load	1000 g
Tripod Head	3D Ball Head
Type	Tripod
Min. Height - Max. Height	16 -19 cm
Weight	270 g

- Classic meets punk: with the mobile phone holder, the tripod can be used as both a classic camera tripod and an innovative mobile phone tripod
- Professional mini tripod: stable and robust workmanship with high-quality materials and screwed-in rather than bonded components to guarantee a tripod with a long service life; aluminium inserts and Nylon-reinforced plastic for additional stabilisation
- With lightweight luggage: the small, stable travel tripod is always with you - with its small packed dimensions, it is the ideal tripod for on the go
- Small, but flexible: the height of the tripod legs can be adjusted in 4 stages, very easily via a sliding locking mechanism with the press of a button on the inside of the tripod legs
- Variety in mini format: selfies, video diaries and blogs - the camera tripod with fold-in tripod legs can easily be used as a selfie stick
- Brings movement to life: the ball head allows perfect orientation for recording in portrait and landscape format

Black				00004630
	6	HB		



hama

„Solid III" Mobile Phone Tripod, Travel Tripod w. Ball Head, Remote Trigger, Max. 80 cm

Thread/Connection	1/4" (6.4 mm), Smartphone holder
Material	Plastic Material
Tripod Head	3D Ball Head
Type	Tripod
Min. Height - Max. Height	22 -80 cm
Weight	345 g

- From influencer to video star: the camera and mobile phone tripod for the ideal height and accessory mounting offers the ideal conditions for every content creator, and is perfect for all online formats, including YouTube, Twitch, Instagram, TikTok and more
- Professional mini tripod: stable and robust workmanship with high-quality materials and screwed-in rather than bonded components to guarantee a tripod with a long service life; aluminium inserts and Nylon-reinforced plastic for additional stabilisation
- With lightweight luggage: the small, stable travel tripod is always with you - with its small packed dimensions, it is the ideal tripod for on the go
- Small, but flexible: the height of the tripod legs can be adjusted in 4 stages, very easily via a sliding locking mechanism with the press of a button on the inside of the tripod legs
- Relaxed arrangement and in the picture: Bluetooth trigger for perfect selfies, group photos and videos – for authentic and high-quality pictures without a selfie stick
- Variety in mini format: selfies, video diaries and blogs - the camera tripod with fold-in tripod legs can easily be used as a selfie stick

Black				00004653
	6	HB		



hama

"Solid 160 2D" Mobile Phone Tripod, Travel Tripod, Remote Release, max. 160 cm

Thread/Connection	1/4" (6.4 mm), Smartphone holder
Leg Segments	5 Sections (4x Extendible)
Material	Aluminium/Plastic Material
Maximum Load	2000 g
Tripod Head	2-Way Head
Type	Tripod
Min. Height - Max. Height	49.5 -160 cm
Maximum Profile Thickness	22.8 mm
Weight	720 g

- From influencer to video star: the mobile phone and camera tripod offers the perfect height for any content creator - ideal for all online formats including YouTube, Twitch, Instagram, TikTok and more.
- Flexible alternative to large tripods: ideal when things need to move quickly or when there isn't enough space for a large tripod, for example
- Its compact size makes it ideal for travelling, holidays, hikes and outdoor trips
- Tripod:
- Ideal 2D head for smartphones or cameras
- With the combination of the tripod and holder, take blur-free photographs with the smartphone
- Can be used completely folded up as a selfie monopod
- Stepless height adjustment with clamps for fixing to achieve more stability

Black				00004669
	16	HB		



hama

Tripod "Flex for Smartphone and GoPro, 14 cm"

Thread/Connection	GoPro, Smartphone holder
Leg Segments	1 Section
Material	Aluminium
Maximum Load	4000 g
Tripod Head	No
Type	Bendable Tripod
Min. Height - Max. Height	7 -14 cm
Maximum Profile Thickness	26 mm
Weight	70 g

- The flexible legs are capable of bending up to 360° which allows optimal, secure attachment to various objects, e.g. railings, branches
- 2-in-1 system for smartphones and GoPro cameras
- Its compact size makes it ideal for travelling, holidays, hikes and outdoor trips
- Sensational, versatile photos and videos from original perspectives and unusual places
- Stepless, individually bendable tripod legs — adaptable to many surfaces and objects and can be used as a hand-held tripod
- For selfies and videos, perfect for video diaries, blogs and ideal for travel and out and about
- No more wobbly, skewed selfies
- Tripod legs encased in high quality foam for maximum flexibility and grip, making them especially pleasant to use in cold weather

Black				00004609
	6	HB		

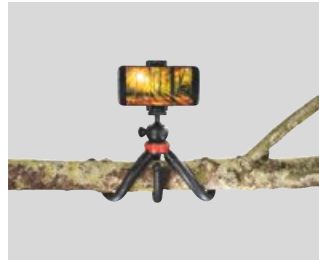

hama

Tripod „FlexPro for Smartphone, GoPro and photocameras, 27 cm"

Thread/Connection	1/4" (6.4 mm), 3D, Ball, GoPro, Smartphone holder
Leg Segments	1 Section
Material	Aluminium/Rubber
Maximum Load	300 g
Tripod Head	Ball Head
Type	Bendable Tripod
Min. Height - Max. Height	16 -27 cm
Maximum Profile Thickness	26 mm
Weight	348 g

- The flexible legs are capable of bending up to 360° which allows optimal, secure attachment to various objects, e.g. railings, branches
- 3-in-1 system for smartphones, GoPro cameras and ¼-inch thread
- The ball head allows perfect alignment for shots in portrait and landscape format
- Its compact size makes it ideal for travelling, holidays, hikes and outdoor trips
- Sensational, versatile photos and videos from original perspectives and unusual places
- Stepless, individually bendable tripod legs — adaptable to many surfaces and objects and can be used as a monopod
- For selfies and videos, perfect for video diaries, blogs and ideal for travel and out and about
- No more wobbly, skewed selfies

Red				00004608
Black				00004605
	6	HB		

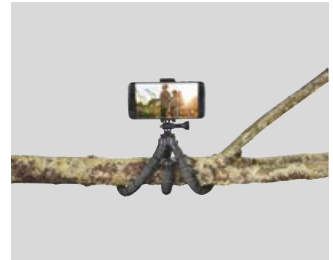

hama

Tripod "Flex for Smartphone and GoPro, 26 cm"

Thread/Connection	GoPro, Smartphone holder
Leg Segments	1 Section
Material	Plastic Material
Maximum Load	300 g
Tripod Head	No
Type	Bendable Tripod
Min. Height - Max. Height	9 -26 cm
Weight	130 g

- The flexible legs are capable of bending up to 360° which allows optimal, secure attachment to various objects, e.g. railings, branches
- 2-in-1 system for smartphones and GoPro cameras
- Its compact size makes it ideal for travelling, holidays, hikes and outdoor trips
- Sensational, versatile photos and videos from original perspectives and unusual places
- Stepless, individually bendable tripod legs — adaptable to many surfaces and objects and can be used as a monopod
- For selfies and videos, perfect for video diaries, blogs and ideal for travel and out and about
- No more wobbly, skewed selfies
- Tripod legs encased in high quality foam for maximum flexibility and grip, making them especially pleasant to use in cold weather
- Extremely flexible, suitable for a smartphone width from 5.5 – 7.8 cm (in horizontal format) thanks to the clamp spring holder

Black				00004613
	6	HB		

Monopods & Tripods



hama

"Fancy 2in1" Mini Tripod for Mobile Phone & Camera (1/4"), Travel Tripod, 16cm, silver

Thread/Connection	1/4" (6.4 mm), Smartphone holder
Leg Segments	2 Sections (1x Extendible)
Material	Plastic Material
Maximum Load	300 g
Tripod Head	3D Ball Head
Type	Mini Tripod
Min. Height - Max. Height	12 -16 cm
Maximum Profile Thickness	10 mm

- Flexible tripod for mobile phone and camera: practical mobile phone holder for smartphone included, which makes it all the more faster to change to the mobile phone camera and back – universal tripod for all situations
- 2in1 system for smartphones, universal 1/4" thread
- With lightweight luggage: the small, stable travel tripod is always with you - with its small packed dimensions, it is the ideal tripod for on the go
- Flexible rubber feet for an improved hold and a secure grip on uneven surfaces
- For selfies and videos, perfect for video diaries, blogs and ideal for travel and out and about
- Compact, handy and space-saving
- Can also be used as a manual tripod
- Can also be used as a stand for a mobile phone or webcam, e.g. on a desk or bedside table

Smartphone holder

- The smartphone holder allows all popular smartphones to be attached to the tripod: extremely flexible, for a smartphone width from 6.5 to 9 cm

Silver				00004666
	72	HB		



hama

"Pocket II Rotation" Smartphone Mini-Tripod

Thread/Connection	1/4" (6.4 mm), Smartphone holder
Leg Segments	1 Section
Material	Plastic Material
Maximum Load	300 g
Tripod Head	No
Type	Mini Tripod
Min. Height - Max. Height	6,5 -6,5 cm
Weight	80 g

- Compact, handy and space-saving
- For selfies and videos, perfect for video diaries, blogs and ideal for travel and out and about
- Mini-tripod with 1/4" connection
- Detachable smartphone holder with 1/4" connection
- Swivel smartphone holder for portrait and landscape format
- Extremely flexible for smartphone widths of between 5.8 and 8.5 cm (in horizontal format) thanks to clamping spring holder
- Rubber inserts on the holder protect the smartphone casing from scratches
- Can also be used as a manual tripod
- Rubberised tripod legs for secure grip
- Can also be used as a stand for the smartphone, e.g. on a desk or bedside table
- Cold shoe for attaching LED lights and microphones, for example

Black, Red				00004649
	16	HB		



hama

"Pocket" Smartphone Mini-Tripod, 20 cm, black

Thread/Connection	Smartphone holder
Leg Segments	1 Section
Material	Plastic Material
Maximum Load	300 g
Tripod Head	No
Type	Mini Tripod
Min. Height - Max. Height	10 -20 cm
Weight	87 g

- Integrated mirror for the perfect selfie angle with the front camera
- The built-in self monopod is ideal for sports and action shots e.g. for filming yourself when skiing
- Compact, handy and space-saving: fits in any pocket because the smartphone holder can be folded

Selfie Stick / Telescopic Rod:

- Telescopic rod extendable to 20 cm for a wide range of action, for e.g. concert recordings, hard-to-reach motifs and group shots
- Torsion-resistant telescopic rod through guide groove
- For selfies and videos, perfect for video diaries, blogs and ideal for travel and out and about
- No more wobbly, skewed selfies
- Extremely flexible, suitable for a smartphone width from 5.0 – 8.5 cm (in horizontal format) thanks to the clamp spring holder
- Rubber inserts on the holder protect the smartphone case from scratches
- Stepless, individually adjustable tripod legs — adaptable to many surfaces and can be used as a hand-held tripod

Black				00004621
	6	HB		

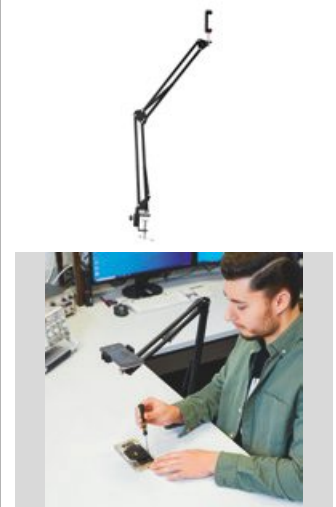

hama

"700 II" Flexible Articulated Arm, 1/4", max. 70 cm, Smartphone Holder, Table

Thread/Connection	1/4" (6.4 mm), Smartphone holder
Leg Segments	2 Sections (1x Extendible)
Material	Metal
Tripod Head	No
Type	Light Stand
Min. Height - Max. Height	70 cm
Weight	468 g

- Adjustable screw clamp for various attachment options: all types of desks, workstations, shelves, bars
- No adapter needed: flexible mobile phone holder for attachment to the articulated arm enclosed, for extraordinary shooting angles and perfect shots for every format
- Vertical and horizontal: ring light, camera, webcam, smartphone or tablet - all of them can be precisely positioned wherever you need them thanks to the two highly flexible joints
- Practical, full-motion holder, ideal for office, kitchen, hobby workshop, influencer/vlogger/blogger/YouTube studio or bedside table
- Maximum length 70 cm
- Allows quick and easy access to the device
- Ideal for taking photographs and making videos, for browsing, watching films or for video chats, but also perfectly suited for use in the office
- Comfortable use: the hands are always free and yet each device is in view or quickly adjusted for another scenario or to prevent it getting in the way

Black				00004660
	24	HB		

Selfie Stick



hama

"Fancy Stand 170" Selfie Stick Tripod for Mobile Phone, Bluetooth® Remote T

Clamping Range From	6,5 cm
Maximum Length	170 cm
Minimum Length	38 cm

- Flexible 2-in-1 construction: fold out the handle of the mobile phone stick and set it up as a smartphone tripod - ideal for spontaneous photos and videos at home, in the studio and when travelling
- From influencer to video star: the mobile phone tripod offers the perfect height for any content creator - ideal for all online formats including YouTube, Twitch, Instagram, TikTok and more
- Plenty of room for manoeuvre: with the infinitely adjustable telescopic rod, this selfie monopod stand opens up completely new perspectives - fully extended or very small as a table tripod (total height 38 cm to 170 cm)
- Ultra-light: the folding, lightweight travel tripod with mobile phone holder weighs just 0.26 kg so you can always bring it with you – capture every moment perfectly, anywhere
- Small and handy mobile phone tripod: the travel tripod with small packed dimensions of just 31 cm is easy to transport and store – the small tripod for on the go for holidays, hiking and outdoor trips
- Relaxed arrangement and in the picture: Bluetooth shutter release for brilliant selfies, group photos and videos - high-quality, authentic images, the outstretched selfie arm is a thing of the past

Black	00004662
6	HB

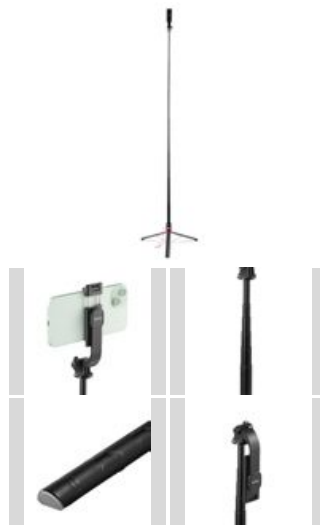

hama

„Fancy Stand 170 II“ Selfie Stick Tripod for Mobile Phone, Bluetooth® Remote Trigger

Clamping Range From	6.2 cm
Clamping Range Up To	9 cm
Maximum Length	170 cm
Minimum Length	38 cm

- Flexible 2-in-1 construction: fold out the handle of the mobile phone stick and set it up as a smartphone tripod - ideal for spontaneous photos and videos at home, in the studio and when travelling
- From influencer to video star: the mobile phone and camera tripod offers the perfect height for any content creator - ideal for all online formats including YouTube, Twitch, Instagram, TikTok and more.
- Plenty of room for manoeuvre: with the infinitely adjustable telescopic rod, this selfie monopod stand opens up completely new perspectives - fully extended or very small as a table tripod (total height 38 cm to 170 cm)
- Ultra-light: the folding, lightweight travel tripod with mobile phone holder weighs just 0.26 kg so you can always bring it with you – capture every moment perfectly, anywhere
- Small and handy mobile phone tripod: the travel tripod with small packed dimensions of just 31 cm is easy to transport and store – the small tripod for on the go for holidays, hiking and outdoor trips
- Relaxed arrangement and in the picture: Bluetooth shutter release for brilliant selfies, group photos and videos - high-quality, authentic images, the outstretched selfie arm is a thing of the past

Black	00004672
6	HB

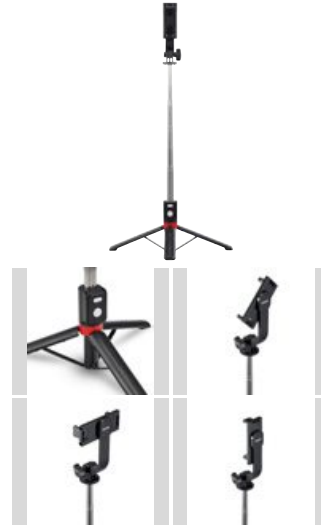

hama

"Fancy Stand 110" Selfie Stick Tripod for Mobile Phone, Bluetooth® Remote T

Clamping Range From	6,5 cm
Clamping Range Up To	9.5 cm
Maximum Length	110 cm
Minimum Length	31 cm

- Its compact size makes it ideal for travelling, holidays, hikes and outdoor trips
- Selfie Monopod / Selfie Stick:
- For selfie photos and videos, blogs, ideal for trips and for on the go
- Completely new perspectives are possible with this selfie monopod
- Perfect selfie stick for streaming, gaming, cooking and DIY hobbies
- Telescopic bar extendable up to 110 cm for a wider field of action, e.g. on selfie or group shots, concerts
- Rotation-proof telescopic bar thanks to guide groove
- With smartphone quick clamp for quick smartphone attachment
- Rotating smartphone holder for portrait and landscape format
- Extremely flexible for a smartphone width from 6.5 to 9.5 cm (landscape format)
- Clamp spring holder ensures a firm grip, with rippled rubber pads on the resting surface to protect the smartphone
- Bluetooth trigger:
- Removable Bluetooth trigger for smartphone and tablet cameras
- Connection via Bluetooth directly with the smartphone, no additional app
- Allows unusual photo and selfie perspectives

Black	00004661
6	HB

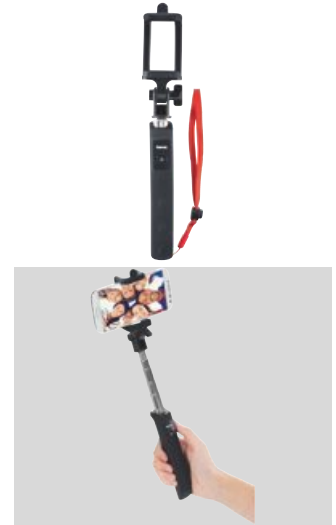

hama

"Fun 70" Selfie, Bluetooth®, black

Clamping Range From	5.5 cm
Clamping Range Up To	8.5 cm
Maximum Length	70 cm
Minimum Length	20.5 cm

- Telescopic bar extendable up to 70 cm for a wider view, e.g. for selfies and group selfies, concerts
- Twist-proof telescopic rod through guide groove
- Connection via Bluetooth directly with the smartphone, no additional app required
- Allows unusual photo and selfie angles
- For selfie photos and videos, blogs, ideal for trips, for life on the move and for action photography
- Better focusing, faster snapshots, resulting in better pictures and sharp, un-blurred selfies
- This selfie monopod opens up completely new perspectives
- With smartphone quick clamp for quick attachment to the smartphone
- Non-slip rubber grip for firm, secure grip
- Extremely flexible, for a smartphone width from 5.5 - 8.5 cm (in horizontal format)
- Compact design
- Clamp spring holder ensures firm grip
- Independent of self-trigger mode
- USB connection: micro USB 2.0

Black	00004315
6	HB

Monopods & Tripods | Tripod Accessories | Holders

SMARTPHONE/TABLET PHOTO ACCESSORIES

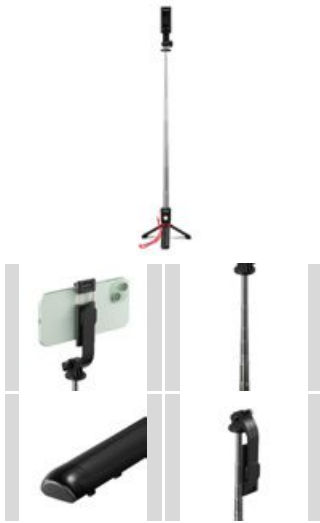

hama

"Fancy Stand 70 II" Selfie Stick Tripod for Mobile Phone, Bluetooth Remote

Clamping Range From	6.2 cm
Clamping Range Up To	9 cm
Maximum Length	70 cm
Minimum Length	23 cm

- Its compact size makes it ideal for travelling, holidays, hikes and outdoor trips
Selfie monopod / selfie stick:
- For selfie photos and videos, blogs, ideal for trips and for life on the move
- This selfie monopod opens up completely new perspectives
- Perfect selfie stick for streaming, gaming, cooking and DIY hobbies
- Telescopic bar extendable up to 70 cm for a wider view, e.g. for selfies and group selfies, concerts
- Twist-proof telescopic rod through guide groove
- With smartphone quick clamp for quick attachment to the smartphone
- Swivel smartphone holder for portrait and landscape format
- Extremely flexible, for a smartphone width from 6.2 - 9.0 cm (landscape format)
- Clamp spring holder ensures firm grip, while ribbed rubber pads on the resting surfaces protect the smartphone

Bluetooth release:

- Removable Bluetooth trigger for smartphone and tablet cameras
- Connection via Bluetooth directly with the smartphone, no additional app
- Allows unusual photo and selfie angles

Black	00004670
48	HB



hama

"Funstand 57" Selfie Stick, with Bluetooth Remote Shutter, black

Clamping Range From	6 cm
Clamping Range Up To	8.5 cm
Maximum Length	57 cm
Minimum Length	16 cm

- Its compact size makes it ideal for travelling, holidays, hikes and outdoor trips
Selfie Monopod / Selfie Stick:
- Ideal for sport and action shots, e.g. filming yourself skiing
- For selfie photos and videos, blogs, ideal for trips and for life on the move
- This selfie monopod opens up completely new perspectives
- Perfect arm extension for wobble-free selfies
- Telescopic bar extendable up to 57 cm for a wider view, e.g. for selfies and group selfies, concerts
- Twist-proof telescopic rod through guide groove
- With smartphone quick clamp for quick attachment to the smartphone
- Swivel smartphone holder for portrait and landscape format
- Non-slip rubber grip for firm, secure grip
- Extremely flexible, for a smartphone width from 6.0 - 8.5 cm (landscape format)
- Clamp spring holder ensures firm grip, while ribbed rubber pads on the resting surfaces protect the smartphone
- Compact design
- Min/max length: 16/57cm

Bluetooth release:

- Removable Bluetooth trigger for smartphone and tablet cameras

Black	00004316
6	HB

Ball Joint/Tilt Head



hama

"Twin Ball 72" Joint

Shade of colour	Black
Thread/Connection	1/4" (6.4 mm)
Weight	35 g

- Ideal attachment arm for vlogger cameras and webcams with 1/4" connection to ring lights with 1/4" connection
- 2 ball joints for customised orientation and fixation of the accessories
- Can be used universally with two 1/4" threads
- Stable metal construction
- Total length 72 mm

00004650
6 HB

Clamp/Tension Bracket



hama

Smartphone Video Handle

Attachment	Tripod Thread 1/4"
Material	Plastic Material
Model	Tripod-Mobile Phone-Holder

- 3 additional threaded connections of 1/4" for professional videos for connection to tripods and 2 additional accessory shoes for further accessories such as LED lights and microphone
- A must-have for anyone who wants to record perfect videos and pictures without "wobble" on their smartphone
- Ideal for eye-level, chest-height or floor-level shots
- Ergonomic grip arch
- Ultra-lightweight and very compact
- Extremely flexible, for a smartphone width from 4.8 - 10.5 cm (in horizontal format)
- 2 accessory shoes for use of video accessories with a standard attachable foot (e.g. LED lights, microphones)
- Extensively rubberised smartphone rest to protect against scratches

Black	00004622
18	HB

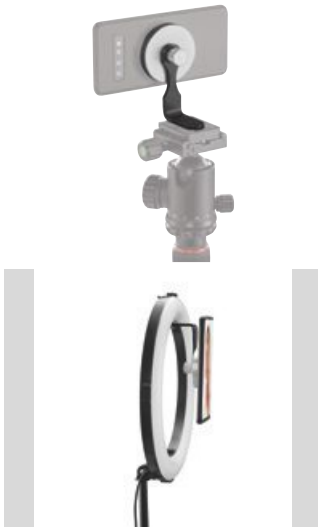

hama

"Puck" Tripod Mobile Phone Holder, Magnetic, Universal

Attachment	Magnet
Material	Metal
Model	Tripod-Mobile Phone-Holder

- Firm grip: the magnetic mobile phone holder keeps the smartphone securely on the magnetic ring and firmly in place without any additional attachments
- The integrated magnetic ring means that the Apple iPhone 15, iPhone 15 Plus, iPhone 15 Pro, iPhone 15 Pro Max, iPhone 14, iPhone 14 Plus, iPhone 14 Pro, iPhone 14 Pro Max, iPhone 13, iPhone 13 mini, iPhone 13 Pro, iPhone 13 Pro Max, iPhone 12, iPhone 12 mini, iPhone 12 Pro Max and iPhone 12 Pro can be easily docked to the mobile phone holder and perfectly positioned without any tedious manual alignment
- Also for other smartphones: simply attach to the magnetic ring with the metal rings provided
- For portrait or landscape format: smartphone can be positioned in any direction
- Rubberised surface to protect the back of the smartphone and for a pleasant feel
- Compact and sturdy aluminium housing with a sophisticated look
- Stable L-holder for strong attachment to all camera tripods, with the supplied connection screw also suitable e.g. for ring lights

					00004655
	6	HB			



hama

"Pro II" Smartphone Holder, 9.5 cm, with "BRS2" Bluetooth® Remote Trigger

Attachment	Tripod Thread 1/4"
Material	Aluminium
Model	Tripod-Mobile Phone-Holder

- Smartphone Holder:
 - Screw-connected universal holder for devices without tripod socket
 - For attaching smartphones to tripods with a 1/4" tripod connection
 - Extremely flexible, for a smartphone width from 4.8 - 9.5 cm (landscape format)
 - No more wobbly, skewed selfies
 - For selfie photos and videos, ideal for video diaries, blogs and for holidays and life on the move
 - Cold shoe for attaching LED lights and microphones, for example
 - Folds to a compact size
 - Only in combination with tripods or telescopic rods featuring a 1/4" connection thread, Arca Swiss
 - Clamp spring holder and recess on the surface ensure a firm grip, while rubber protects the housing from scratches
- Bluetooth release:
- For smartphone cameras, ideal for selfies
 - Connection via Bluetooth directly with the smartphone
 - Allows unusual photo and selfie angles
 - Safe photography in high-action situations
 - Better focusing, faster snapshots, resulting in better pictures and sharp, un-blurred selfies

Black					00004633
	12	HB			



hama

2in1 Smartphone / Tablet Holder, 1/4"

Material	Plastic Material
----------	------------------

- Screw-connected universal holder for devices without tripod socket
- Extremely flexible for a smartphone width from 5.5 to 8.2 cm and a tablet width from 11.2 to 18.5 cm (in horizontal format)
- Compact design
- For selfie photos and videos, ideal for video diaries, blogs and for holidays and life on the move
- Only in combination with tripods featuring a 1/4" connection thread or with telescopic rods
- No more wobbly, skewed selfies
- Clamp spring holder and recess on the surface ensure a firm grip, while rubber protects the housing from scratches

Black					00004638
	6	HB			



hama

"Pro" 2in1 Smartphone / Tablet Holder, 1/4"

Attachment	Tripod Thread 1/4"
Material	Plastic Material/Steel
Model	Tripod-Mobile Phone-Holder

- Screw-connected universal holder for devices without tripod socket
- Compact design with red toggle switch to increase the size from 6.5 to 17.5 cm
- Cold shoe for attaching LED lights and microphones, for example
- Clamp spring holder and recess on the surface ensure a firm grip, while rubber protects the housing from scratches
- Only in combination with tripods featuring a 1/4" connection thread or with telescopic rods
- For better selfie photos and videos, ideal for video diaries and blogs, ideal for day trips and travel

Black					00004645
	16	HB			



hama

"Bottle Pod Fun" Mobile Phone Holder for Bottles, for Smartphones 5.8 - 8.5

Attachment	Tripod Thread 1/4"
Material	Silicone

- When the bottles empty, the fun really begins: the perfect gadget for spontaneous pictures at birthday, bbq parties and après-ski
- For all common drinks bottles
- Tripod attachment with smartphone holder in a compact pocket format, can travel to any party in a pocket
- Perfect grip in the bottle thanks to tapered silicone cone
- Swivel smartphone holder for portrait and landscape format
- Extremely flexible for smartphone widths from 5.8 to 8.5 cm thanks to clamping spring holder
- Rubber inserts on the holder protect the smartphone casing from scratches
- Mini tripod: silicone cone separately suitable for cameras with 1/4" connection
- With cold shoe

Black				00004654
	16	HB		



hama

"Pro II" Smartphone Holder, 9.5 cm, 1/4"

Material	Plastic Material
Model	Tripod-Mobile Phone-Holder

- Screw-connected universal holder for devices without tripod socket
- Extremely flexible, for a smartphone width from 4.8 - 9.5 cm (landscape format)
- No more wobbly, skewed selfies
- For selfies and videos, perfect for video diaries, blogs and ideal for travel and out and about
- Cold shoe for attaching LED lights and microphones, for example
- Folds to a compact size
- Only in combination with tripods or telescopic rods featuring a 1/4" connection thread, Arca Swiss
- Clamp spring holder and recess on the surface ensure a firm grip, while rubber protects the housing from scratches

Black				00004648
	24	HB		



hama

Smartphone Holder, 8.2 cm, 1/4"

Attachment	Tripod Thread 1/4"
Material	Plastic Material
Model	Tripod-Mobile Phone-Holder

- Screw-connected universal holder for devices without tripod socket
- Extremely flexible, for a smartphone width from 5.5 - 8.2 cm (in horizontal format)
- Compact design
- For selfie photos and videos, ideal for video diaries, blogs and for holidays and life on the move
- Only in combination with tripods featuring a 1/4" connection thread or with telescopic rods
- No more wobbly, skewed selfies
- Clamp spring holder and recess on the surface ensure a firm grip, while rubber and foam padding protect the housing from scratches

Black				00004637
	24	HB		

Monitor Arm



hama

Monitor Holder for Streaming Setup, 4 Arms, Height-adjustable, Swivel

Shade of colour	Black
Max. Monitor Size	81 cm

- Perfect for the next streaming or gaming session: whether webcam, microphone, smartphone or tablet, ring light or camera, monitor or laptop, there is room for a lot of streaming equipment on the four arms, making it ideal for bloggers, streamers, gamers and so on
- For an ergonomic workstation: the streaming arm adapts to your personal requirements and posture. Whether you need stepless height adjustability, swivel and tilt functions, pull-out capability or portrait or landscape formats, this is how ergonomics works in the office and home office while gaming
- Space for two monitors: the monitor arms be used for all common screen sizes with a diagonal of 33 - 81 cm (13 - 32") and up to a weight of 8 kg per arm
- Unusual recording angle: Streaming light or camera can be rotated and tilted thanks to tripod ball head - for the perfect streaming setup
- Always the perfect recording position: Portrait and landscape format thanks to swivelling smartphone and tablet holder
- For tidy workstations: Cable management guides the monitor cable tidily behind the screen, avoiding cable spaghetti and saving space. The cable guide also protects the cable against breakage thanks to strain relief

				00004663
	1	SC		

Wireless Shutter Release



hama

"BR53" Bluetooth® remote shutter release

Shade of colour	Black
Bluetooth Version	4.0

- Connection via Bluetooth directly with the smartphone or tablet
- Allows unusual photo and selfie angles
- For selfie photos and videos, blogs, ideal for trips, for life on the move and for action photography
- Better focusing, faster snapshots, resulting in better pictures and sharp, un-blurred selfies
- If the smartphone or tablet is positioned in a suitable spot, both arms can remain free - the extended selfie arm is passé
- Safe photography in high-action situations
- Perfect for party and group shots because the range of up to 10 m allows a much wider image field
- Independent of self-trigger mode
- Small and compact, the Bluetooth shutter release can go anywhere

00004639		
24	HB	

Microphone



hama

"RMN Uni" Directional Microphone, for Accessory Shoe

Shade of colour	Black
Connection	3.5 mm Jack Plug
Directivity	Uni-directional
Model	Mono
Cable Length	0.32 m

- From smartphones to camcorders - for bloggers or film-makers: the microphone is ideal for all devices
- The vibration-attenuating anti-shock frame absorbs mechanical vibration and noise
- Passive, dynamic directional microphone

00004647		
10	HB	



hama

"Smart" Lavalier Microphone

Shade of colour	Black
Connection	3.5 mm Jack Plug
Directivity	omni-directional
Model	Mono
Cable Length	6 m

- From smartphones to camcorders - for bloggers or film-makers: the microphone is ideal for all devices
- 6 metres for plenty of room to manoeuvre: reporters, vloggers and influencers therefore have plenty of freedom for their voice and video recordings

00004634		
6	HB	

Tripods & Accessories



Monopods & Tripods

Tripod



hama

"Profil Duo" Tripod, 150 - 3D

Thread/Connection	1/4" (6.4 mm)
Leg Segments	3 Sections (2x Extendible)
Material	Aluminium
Maximum Load	5000 g
Tripod Head	3D: 3-Way Head
Type	Tripod
Min. Height - Max. Height	53 -150 cm
Maximum Profile Thickness	22 mm
Weight	1480 g

- The 3D tilt head allows perfect alignment for landscape and portrait shots
- Quick-release plate for quickly changing the camera
- The central column can be removed to be used as a fully functioning monopod
- Large, functional quick-action leg locks for fast and simple locking of the leg length in any position
- Spirit level integrated into the tripod head and base
- With rubber feet for secure stand
- Non-slip foam handles on the stand legs for use in all weathers
- Monopod, min. height 45 cm/max. height 162 cm
- Replacement coupling plate Item no. 00004471

Black	00004481
	6 SC



hama

"Action Smart 165 3D" Tripod with 3-way Head and Smartphone Holder

Thread/Connection	1/4" (6.4 mm)
Leg Segments	3 Sections (2x Extendible)
Material	Aluminium
Maximum Load	4000 g
Tripod Head	3-Way Head
Type	Tripod
Min. Height - Max. Height	61 -165 cm
Maximum Profile Thickness	23 mm
Weight	1400 g

- One tripod, many possibilities: flexible photography and filming with a smartphone, digital camera and video camera
- The 3D tilt head allows perfect alignment for landscape and portrait shots
- Quick-release plate for quickly changing the camera
- The spikes at the tripod feet ensure that a particularly firm and steady grip is maintained on soft or slippery surfaces
- Spirit level integrated into the tripod head and base
- With crank for stepless height adjustment of the central column
- Fixable cross-struts and flexible rubber feet for secure positioning on uneven surfaces
- Functional quick-action leg locks for fast and simple locking of the leg length in any position
- Handle
- Non-slip foam handles on the stand legs for use in all weathers

Black	00004491
	6 SC



hama

"TAR Duo" Tripod, 165 - Ball

Thread/Connection	1/4" (6.4 mm)
Leg Segments	4 Sections (3x Extendible)
Material	Aluminium
Maximum Load	8000 g
Tripod Head	3D Ball Head with Pan function
Type	Tripod
Min. Height - Max. Height	50 -165 cm
Maximum Profile Thickness	26 mm
Weight	1600 g

- Ball head with panorama function allows perfect orientation for recording in portrait and landscape
- Quick-release plate for quickly changing the camera
- Inverted position allows macrophotographs near the ground
- In combination with a leg segment the removable central column can be used as a fully functioning monopod
- Lightweight and sturdy aluminium construction
- Functional quick-action leg locks for fast and simple locking of the leg length in any position
- With rubber feet for secure stand
- Compact pack size of 45 cm thanks to foldable tripod legs
- Spirit level integrated into the tripod head
- Quick-change plate with rubber lining
- Telescoping central pillar with weight hooks for improved stability during windy conditions and on rough terrain
- Tripod legs can be spread apart in increments (3 increments)
- Non-slip foam grip on the tripod legs for use in all weathers

Black	00004475
	6 SC

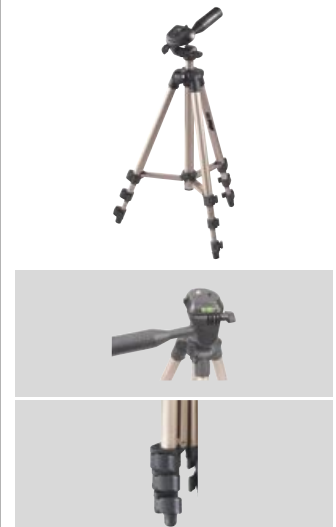

hama

"Star 5" Tripod

Thread/Connection	1/4" (6.4 mm)
Leg Segments	4 Sections (3x Extendible)
Material	Aluminium
Maximum Load	500 g
Tripod Head	3D: 3-Way Head
Type	Tripod
Min. Height - Max. Height	36,5 -106.5 cm
Maximum Profile Thickness	16.8 mm
Weight	520 g

- The 3D tilt head allows perfect alignment for landscape and portrait shots
- Quick-release plate for quickly changing the camera
- Spirit level integrated into the tripod head
- Continuous height adjustment of the centre column
- Leg braces and rubber feet for a firm and steady grip
- With the functional quick-action leg locks the tripod legs can easily and quickly be fixed at the required height or position

Champagne	00004105
	15 SC



hama

"Star 20" Tripod

Thread/Connection	1/4" (6.4 mm)
Leg Segments	3 Sections (2x Extendible)
Material	Aluminium
Maximum Load	2000 g
Tripod Head	3D: 3-Way Head
Type	Tripod
Min. Height - Max. Height	47 -125 cm
Maximum Profile Thickness	21 mm
Weight	780 g

- The 3D tilt head allows perfect alignment for landscape and portrait shots
- Quick-release plate for quickly changing the camera
- Spirit level integrated into the tripod head
- Continuous height adjustment of the centre column
- Leg braces and rubber feet for a firm and steady grip
- With the functional quick-action leg locks the tripod legs can easily and quickly be fixed at the required height or position

Silver	00004117
	9 SC



hama

"Star 61" Tripod

Thread/Connection	1/4" (6.4 mm)
Leg Segments	3 Sections (2x Extendible)
Material	Aluminium
Maximum Load	3000 g
Tripod Head	3D: 3-Way Head
Type	Tripod
Min. Height - Max. Height	60 -153 cm
Maximum Profile Thickness	20 mm
Weight	1220 g

- The 3D tilt head allows perfect alignment for landscape and portrait shots
- Quick-release plate for quickly changing the camera
- Spirit level integrated into the tripod head and spirit vial at the base
- With crank for continuous height adjustment of the centre column
- Lockable leg braces and flexible rubber feet for a firm and steady grip on uneven surfaces
- With the functional quick-action leg locks the tripod legs can easily and quickly be fixed at the required height or position
- Handle
- With hook for weighing the tripod down in strong winds and on rough terrain
- Spare quick release plate: Hama item no. 00004154

Champagne	00004161
	6 SC



hama

"Star 62" Tripod

Thread/Connection	1/4" (6.4 mm)
Leg Segments	3 Sections (2x Extendible)
Material	Aluminium
Maximum Load	4000 g
Tripod Head	3D: 3-Way Head
Type	Tripod
Min. Height - Max. Height	64 -160 cm
Maximum Profile Thickness	23 mm
Weight	1500 g

- The 3D tilt head allows perfect alignment for landscape and portrait shots
- Quick-release plate for quickly changing the camera
- Spirit level integrated into the tripod head and spirit vial at the base
- With crank for continuous height adjustment of the centre column
- Lockable leg braces and flexible rubber feet for a firm and steady grip on uneven surfaces
- With the functional quick-action leg locks the tripod legs can easily and quickly be fixed at the required height or position
- Handle
- With hook for weighing the tripod down in strong winds and on rough terrain
- Spare quick release plate: Hama item no. 00004154

Champagne	00004162
	6 SC



hama

"Star 63" Tripod

Thread/Connection	1/4" (6.4 mm)
Leg Segments	3 Sections (2x Extendible)
Material	Aluminium
Maximum Load	4000 g
Tripod Head	3D: 3-Way Head
Type	Tripod
Min. Height - Max. Height	66 -166 cm
Maximum Profile Thickness	26.7 mm
Weight	1740 g

- The 3D tilt head allows perfect alignment for landscape and portrait shots
- Quick-release plate for quickly changing the camera
- Spirit level integrated into the tripod head and spirit vial at the base
- With crank for continuous height adjustment of the centre column
- Lockable leg braces and flexible rubber feet for a firm and steady grip on uneven surfaces
- With the functional quick-action leg locks the tripod legs can easily and quickly be fixed at the required height or position
- Handle
- With hook for weighing the tripod down in strong winds and on rough terrain
- Spare quick release plate: Hama item no. 00004154

Champagne	00004163
	6 SC

Monopods & Tripods

TRIPODS & ACCESSORIES



hama

"Star 64" Tripod

Thread/Connection	1/4" (6.4 mm)
Leg Segments	3 Sections (2x Extendible)
Material	Aluminium
Maximum Load	4000 g
Tripod Head	3D: 3-Way Head
Type	Tripod
Min. Height - Max. Height	69 -185 cm
Maximum Profile Thickness	26.7 mm
Weight	1660 g

- The 3D tilt head allows perfect alignment for landscape and portrait shots
- Quick-release plate for quickly changing the camera
- Spirit level integrated into the tripod head and spirit vial at the base
- With crank for continuous height adjustment of the centre column
- Lockable leg braces and flexible rubber feet for a firm and steady grip on uneven surfaces
- With the functional quick-action leg locks the tripod legs can easily and quickly be fixed at the required height or position
- Handle
- With hook for weighing the tripod down in strong winds and on rough terrain
- Spare quick release plate: Hama item no. 00004154

Champagne				00004464
	6	SC		



hama

"Star 75" Tripod

Thread/Connection	1/4" (6.4 mm)
Leg Segments	4 Sections (3x Extendible)
Material	Aluminium
Maximum Load	2500 g
Tripod Head	3D: 3-Way Head
Type	Tripod
Min. Height - Max. Height	42.5 -125 cm
Maximum Profile Thickness	19.8 mm
Weight	620 g

- The 3D tilt head allows perfect alignment for landscape and portrait shots
- Quick-release plate for quickly changing the camera
- Spirit level integrated into the tripod head
- Continuous height adjustment of the centre column
- Leg braces and rubber feet for a firm and steady grip
- With the functional quick-action leg locks the tripod legs can easily and quickly be fixed at the required height or position

Champagne				00004175
	15	SC		

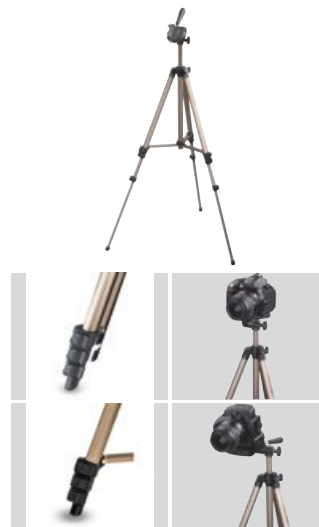

hama

"Star 700 EF Digital" Tripod

Thread/Connection	1/4" (6.4 mm)
Leg Segments	4 Sections (3x Extendible)
Material	Aluminium
Maximum Load	2500 g
Tripod Head	3D: 3-Way Head
Type	Tripod
Min. Height - Max. Height	42.5 -125 cm
Maximum Profile Thickness	19.8 mm
Weight	620 g

- The 3D tilt head allows perfect alignment for landscape and portrait shots
- Spirit level integrated into the tripod head
- Continuous height adjustment of the centre column
- Leg braces and rubber feet for a firm and steady grip
- With the functional quick-action leg locks the tripod legs can easily and quickly be fixed at the required height or position

Champagne				00004133
	15	SC		



hama

"Traveller 117 Ball" Tripod

Thread/Connection	1/4" (6.4 mm)
Leg Segments	3 Sections (2x Extendible)
Material	Aluminium
Maximum Load	4000 g
Tripod Head	3-Way Head
Type	Tripod
Min. Height - Max. Height	35 -117 cm
Maximum Profile Thickness	20 mm
Weight	820 g

- The ball head allows perfect alignment for shots in portrait and landscape format
- Its compact size makes it ideal for travelling, holidays, hikes and outdoor trips
- Lightweight aluminium design
- With the functional quick-action leg locks the tripod legs can easily and quickly be fixed at the required height or position
- Rubber feet for a firm and steady grip
- The legs are covered with non-slip foam which makes the tripod suitable for all kinds of weather
- With hook for weighing the tripod down in strong winds and on rough terrain

Black				00004290
	6	SC		

Monopods & Tripods



hama

"Traveller 163 Ball" Tripod

Thread/Connection	1/4" (6.4 mm)
Leg Segments	3 Sections (2x Extendible)
Material	Aluminium
Maximum Load	4000 g
Tripod Head	3-Way Head
Type	Tripod
Min. Height - Max. Height	47 -163 cm
Maximum Profile Thickness	23 mm
Weight	1350 g

- The ball head allows perfect alignment for shots in portrait and landscape format
- Quick-release plate for quickly changing the camera
- Inverted position allows macrophotographs near the ground
- The spikes at the tripod feet ensure that a particularly firm and steady grip is maintained on soft or slippery surfaces
- Its compact size makes it ideal for travelling, holidays, hikes and outdoor trips
- Lightweight aluminium design
- Spirit vial at the ball head
- Quick release plate with safety catch and "click function" for quick and easy camera change with just one click
- Brake for locking the centre column into place
- With the functional quick-action leg locks the tripod legs can easily and quickly be fixed at the required height or position
- Expandable legs for optimum proximity to the ground
- Rubber feet for a firm and steady grip

Black	00004291
	6 SC



hama

"Gamma 153" Tripod, 3D

Thread/Connection	1/4" (6.4 mm)
Leg Segments	3 Sections (2x Extendible)
Material	Aluminium
Maximum Load	3000 g
Tripod Head	3-Way Head
Type	Tripod
Min. Height - Max. Height	58 -153 cm
Maximum Profile Thickness	20 mm
Weight	990 g

- The 3D tilt head allows perfect alignment for landscape and portrait shots
- Quick-release plate for quickly changing the camera
- Spirit vial at the base
- Crank for continuous height adjustment of the central column
- With the functional quick-action leg locks the tripod legs can easily and quickly be fixed at the required height or position
- Handle
- Spare quick release plate: Hama item no. 00004154

Black	00004096
	10 SC



hama

"Delta 160" Tripod, 3D

Thread/Connection	1/4" (6.4 mm)
Leg Segments	3 Sections (2x Extendible)
Material	Aluminium
Maximum Load	4000 g
Tripod Head	3-Way Head
Type	Tripod
Min. Height - Max. Height	62 -160 cm
Maximum Profile Thickness	26 mm
Weight	1590 g

- The 3D tilt head allows perfect alignment for landscape and portrait shots
- Quick-release plate for quickly changing the camera
- Large, functional quick-action leg locks for fast and simple locking of the leg length in any position
- With crank for stepless height adjustment of the central column
- Spirit level integrated into the tripod head and base
- With rubber feet for secure stand
- Spikes on the tripod feet ensure an especially sturdy position on soft or slippery surfaces
- Replacement quick coupling plate (rubber): Item No. 00004424

Black	00004097
	6 SC



hama

"Delta Duo 170" Tripod, 3D

Thread/Connection	1/4" (6.4 mm)
Leg Segments	3 Sections (2x Extendible)
Material	Aluminium
Maximum Load	4000 g
Tripod Head	3-Way Head
Type	Tripod
Min. Height - Max. Height	62 -170 cm
Maximum Profile Thickness	26 mm
Weight	1850 g

- The 3D tilt head allows perfect alignment for landscape and portrait shots
- Quick-release plate for quickly changing the camera
- The central column can be removed to be used as a fully functioning monopod
- Large, functional quick-action leg locks for fast and simple locking of the leg length in any position
- Spirit level integrated into the tripod head and base
- With rubber feet for secure stand
- Spikes on the tripod feet ensure an especially sturdy position on soft or slippery surfaces
- Monopod, min. height 59 cm/max. height 148 cm
- Replacement quick coupling plate (rubber): Item No. 00004424

Black	00004098
	6 SC

TRIPODS & ACCESSORIES

Monopods & Tripods

TRIPDS & ACCESSORIES



hama

"Ramble II Duo Carbon" travel tripod for camera and mobile phone, 170cm

Thread/Connection	1/4" (6.4 mm), Smart-phone holder
Leg Segments	4 Sections (3x Extendible)
Material	Carbon
Maximum Load	8000 g
Tripod Head	Ball Head with Panoramic Function
Type	Mono Tripod/Tripod
Min. Height - Max. Height	46 -160 cm
Maximum Profile Thickness	25 mm
Weight	1620 g

- The ultra-lightweight carbon travel tripod, including ball head and mobile phone holder, weighs just 1.6 kg so you can always have it at hand – capture every moment perfectly, anywhere
- Simply unfold the legs: The travel tripod with a small packed size of just 45 cm is easy to transport and store – the most compact camera tripod for travel
- To be on the safe side: the lightweight carbon tripod can stably and reliably hold up to 8 kg – including camera or smartphone with mount, microphone or light as well as a safety weight on the central column
- Precise alignment: Ball head with panorama function allows perfect orientation for recording in portrait and landscape – from portrait photography to scenes to landscape images
- Conveniently adjust the ball head: use the friction screw to set how smoothly the ball head can be adjusted. The spirit level shows the exact horizontal alignment

Carbon		00004486
	6 SC	



hama

"Star 78 Mono" Monopod

Thread/Connection	1/4" (6.4 mm)
Leg Segments	4 Sections (3x Extendible)
Material	Aluminium
Maximum Load	4000 g
Tripod Head	3D: 3-Way Head
Type	Mono Tripod
Min. Height - Max. Height	61 -176 cm
Maximum Profile Thickness	26.7 mm
Weight	665 g

- The 3D tilt head allows perfect alignment for landscape and portrait shots
- Quick-release plate for quickly changing the camera
- Flexible rubber foot for a firm grip on uneven surfaces and for easy camera alignment in different positions
- With the functional quick-action leg locks the leg of the monopod can easily and quickly be fixed at the required height or position
- Spirit level integrated into the monopod head
- The non-slip, rubber-coated handle allows you to use the monopod in all weathers
- Spare quick release plate: Hama item no. 00004154

Champagne		00004178
	10 SC	

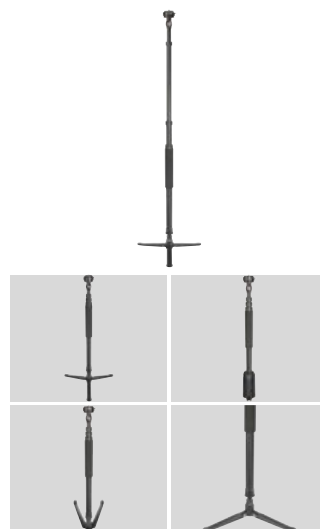

hama

"Smooth" Monostand, 155 Click, with Three-Arm Base

Thread/Connection	1/4" (6.4 mm)
Leg Segments	4 Sections (3x Extendible)
Material	Aluminium
Maximum Load	5000 g
Tripod Head	No
Type	Mono Tripod
Min. Height - Max. Height	63,5 -155 cm
Maximum Profile Thickness	28 mm
Weight	900 g

- Air lock system: stepless adjustment without screw clamps - for more speed when hunting for the perfect shot
- A cleverly attached joint at the end of the tripod ensures gentle and smooth movements and pivoting, with the joint allowing tilts of up to 20° in all directions
- Flexible alternative to large tripods: ideal when things have to happen fast, if there's not much space for a large tripod, for example, for photographing with large lenses, for animal shots with large focal lengths
- Also for fascinating 360° panoramic shots and vivid indoor and property photographs
- The monopod's three leg segments are extendable, and each of them is individually steplessly adjustable, making them perfect for custom positioning even up to eye level height
- Made from sturdy and lightweight aluminium, weighing 900 grams and, thanks to its small dimensions, is also suitable for travel

Black		00004468
	12 SC	



hama

"Flex 2in1" Mini-Tripod for Photo Cameras and GoPro, 14 cm

Thread/Connection	1/4" (6.4 mm), GoPro
Leg Segments	1 Section
Material	Aluminium
Maximum Load	300 g
Tripod Head	No
Type	Bendable Tripod
Min. Height - Max. Height	7.5 -14 cm
Weight	64 g

- The flexible legs are capable of bending up to 360° which allows optimal, secure attachment to various objects, e.g. railings, branches
- 2in1 system for 1/4 inch threads and GoPro cameras
- Its compact size makes it ideal for travelling, holidays, hikes and outdoor trips
- Non-slip foam on the tripod legs
- Can of course also be used as a normal table tripod

Black		00004557
	6 HB	



hama

"Flexi" Mini-Tripod, M, black

Thread/Connection	1/4" (6.4 mm)
Leg Segments	1 Section
Material	Plastic Material
Maximum Load	200 g
Tripod Head	No
Type	Bendable Tripod
Min. Height - Max. Height	7 -10 cm
Weight	44 g

- With clip for attaching to a camera bag, belt or shirt pocket, etc.
- Compact mini-tripod with flexible legs
- Can be used as a tabletop tripod for all compact cameras with 1/4" (6.4 mm) tripod thread

Black	00004552
6 HB	



hama

Tripod
"Ball L"

Thread/Connection	1/4" (6.4 mm)
Leg Segments	2 Sections (1x Extendible)
Material	Aluminium
Maximum Load	300 g
Tripod Head	3D Ball Head
Type	Mini Tripod
Min. Height - Max. Height	14 -21 cm
Weight	114 g

- The ball head allows perfect alignment for shots in portrait and landscape format
- For photo and video cameras, microphones and mini-loudspeakers

Silver	00004551
Black	00004555
6 HB	



hama

"Ball" Mini-Tripod, XL, black/silver

Thread/Connection	1/4" (6.4 mm), 3D, Ball
Leg Segments	3 Sections (2x Extendible)
Material	Plastic Material
Maximum Load	300 g
Tripod Head	3D Ball Head
Type	Mini Tripod
Min. Height - Max. Height	14 -26 cm
Weight	122 g

- The ball head allows perfect alignment for shots in portrait and landscape format
- For photo and video cameras, microphones and mini-loudspeakers

Black	00004556
6 HB	



hama

Suction Mount with Ball Head 360 for GoPro

Thread/Connection	1/4" (6.4 mm), GoPro
Leg Segments	1 Section
Material	Plastic Material
Maximum Load	300 g
Tripod Head	3D Ball Head
Type	Suction Stand
Min. Height - Max. Height	5 -11 cm
Weight	180 g

- The ball head allows perfect alignment for shots in portrait and landscape format
- For GoPro action cameras and digital cameras with a 1/4" connection thread
- 3D ball head with 360° rotation
- Can also be used as a car pod
- Diameter of the suction cup: 90 mm
- Thread length adjustable, therefore universally usable

Black	00004356
6 BK	

Monopods & Tripods | Tripod Accessories

TRIPODS & ACCESSORIES



hama

Lighting Tripod 200

Thread/Connection	1/4" (6.4 mm)
Leg Segments	1 Section
Material	Metal
Maximum Load	2500 g
Tripod Head	No
Type	Light Stand
Min. Height - Max. Height	75 -200 cm
Maximum Profile Thickness	24 mm
Weight	980 g

- Stable design thanks to cross-struts
- Functional quick-action leg locks for rapid and simple locking
- Especially lightweight, therefore ideal for shots outside the studio

Black					00004084
	6	SC			

Ball Joint/Tilt Head



hama

Ball Head, height: 50 mm

Shade of colour	Black
Thread/Connection	1/4" (6.4 mm)
Diameter	30 mm
Height	50 mm
Weight	114 g

- (A) 1/4" (6.4 mm) camera screw
- (B) 1/4" (6.4 mm) and (B) 3/8" (9.5 mm) screw hole

					00005014
	6	BK			



hama

Ball Head, height: 38 mm

Shade of colour	Black
Thread/Connection	1/4" (6.4 mm)
Diameter	20 mm
Height	38 mm
Weight	36 g

- (B) 1/4" (6.4 mm) screw hole
- (A) 1/4" (6.4 mm) camera screw

					00005011
	6	BK			

Camera Plate



hama

Quick Release Plate for Delta Pro 180 Ball

Shade of colour	Black
Thread/Connection	1/4" (6.4 mm)
Material	Aluminium
Width x Height	6 x 5 cm

					00004414
	6	BK			



hama

Quick Release Plate for Traveller Premium 144/146

Shade of colour	Black
Thread/Connection	1/4" (6.4 mm)
Material	Aluminium
Width x Height	4 x 3.5 cm

					00004243
	6	BK			



hama

Tripod Camera Plate for Traveller 150 Prem. Duo & Prof. Premium Duo Carbon

Shade of colour	Black
Thread/Connection	1/4" (6.4 mm)
Material	Aluminium
Width x Height	4 x 4 cm

- For "Traveller 150 Premium Duo" tripod, Item No.: 00004265
- For "Professional Premium Duo Carbon" tripod, Art. No.: 00004286

					00004246
	6	BK			



hama

Quick-release Plate for Tripod, Arca-Swiss-Compatible

Shade of colour	Black
Thread/Connection	1/4" (6.4 mm)
Material	Aluminium
Width x Height	5 x 3.9 cm

					00004463
	6	BK			



hama

"Click II" Tripod Camera Plate

Shade of colour	Black
Thread/Connection	1/4" (6.4 mm)
Material	Aluminium
Width x Height	4.17 x 4.17 cm

- For Gamma tripods
- For lightweight SLR cameras and camcorders
- Spring video pin, camera plate with A 1/4" screw (6.4 mm)

00004376	
216	BK



hama

Quick-Release Plate for Omega Premium I, II and III

Shade of colour	Black
Thread/Connection	1/4" (6.4 mm)
Material	Plastic Material
Width x Height	5.3 x 4.2 cm

00004262	
6	BK



hama

Quick Release Plate for "Delta 160", 3D/"Delta Duo 170", 3D Tripods

Shade of colour	Black
Thread/Connection	1/4" (6.4 mm)
Material	Plastic Material
Width x Height	7 x 5.2 cm

- Video pin

00004424	
6	BK

Conversion Bushings



hama

Adaptermount 1/4" to 3/8" "GS5000", Silver

- (A) 3/8" (9.5 mm) threaded stem
- (B) 1/4" (6.4 mm) threaded hole

00005120	
6	BK



hama

Quick Release Plate for "Traveller 163 Ball" Tripod

Shade of colour	Black
Thread/Connection	1/4" (6.4 mm)
Material	Cork
Width x Height	4 x 3.9 cm

00004439	
6	BK



hama

Quick Release Plate for "Star 55-64", "Star 200", "Gamma 153", "Action 165"

Shade of colour	Black
Thread/Connection	1/4" (6.4 mm)
Material	Plastic Material
Width x Height	6.6 x 5.1 cm

00004154	
6	BK



hama

Tripod Camera Plate for "Star 75" Tripod

Shade of colour	Black
Thread/Connection	1/4" (6.4 mm)
Material	Plastic Material
Width x Height	4.7 x 3.5 cm

- With video pin

00004008	
6	BK

Tripod Accessories | Mounting Materials

TRIPODS & ACCESSORIES

Socket



hama

**Tripod Conversion Screws,
(A) 1/4" (6.4 mm) > (B) 3/8"
(9.5 mm)**

Shade of colour	Silver
Diameter	25 mm

- (A) 1/4" (6.4 mm) threaded stem
- (B) 3/8" (9.5 mm) threaded hole

			00005121
	6	BK	



hama

**Tripod Conversion Screws,
(A) 3/8" (9.5 mm) > (B) 1/4"
(6.4 mm)**

Shade of colour	Silver
Diameter	25 mm

- (A) 3/8" (9.5 mm) threaded stem
- (B) 1/4" (6.4 mm) threaded hole

			00005122
	6	BK	

Clamp Extensions



hama

"Studio Clamp 40", Set of 3

Shape	Wedge
-------	-------

- Powerful spring clamp
- Support opening: approx. 60 mm, clamping width: approx. 40 mm
- Width: approx. 80 mm

			00021205
	30	HB	

Screw



hama

Camera Screws, 11 mm

- (A) 1/4" (6.4 mm) threaded mount
- (B) 1/4" (6.4 mm) threaded hole

			00005134
	6	BK	

Filter & Accessories

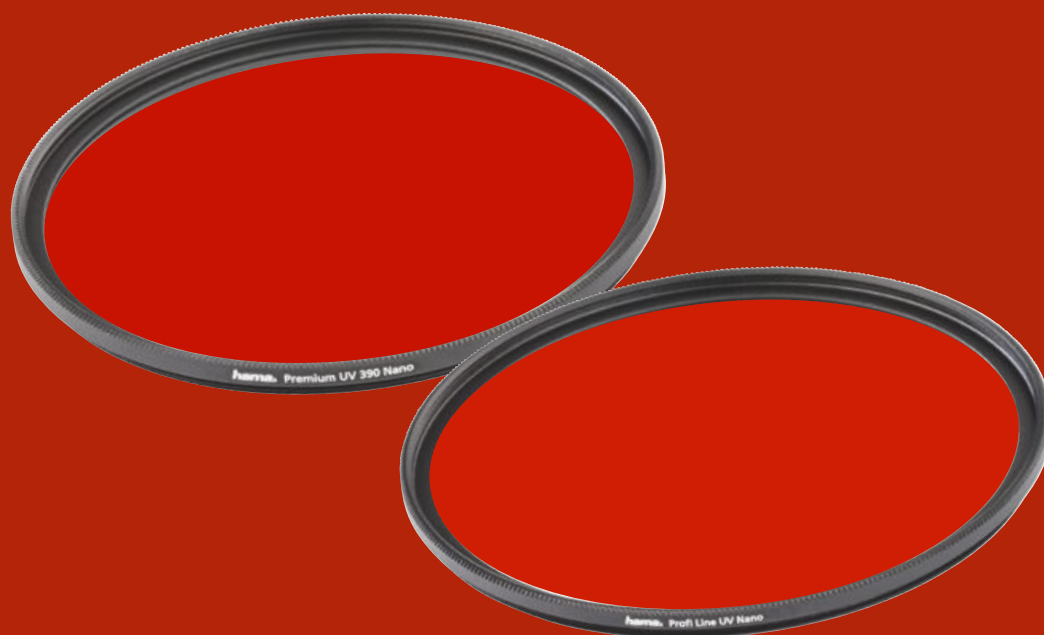

Photo filter

FILTER & ACCESSORIES

Lens filter



hama

Lens filter
"Gray Filter Set ND58, ND64, ND100, with Filter Bag"

Coating	NMC16 (Nano Multi-Coated 16-fold)
Metal Mount	Black
Mount Thickness	2.9 mm
Type	Grey Filter
Type of Glass	High-Grade Lens Glass

- Exposure correction: 8x = 3 aperture values; 64 = 6 aperture values; 1000 = 10 aperture values
- NMC16 coating: eight layers on each side, for maximum anti-reflective properties
- Vapour-deposited nano-coating
- Developed especially for digital cameras thanks to double-sided coating
- With front thread for other filters, lens cap or lens hood
- Quality class (glass): high-quality lens glass

Picture impact:

- Running water is portrayed as soft and flowing by long exposure times
- Popular squares become void of people through long-term exposure

58 mm					00076899
			10	HB	
62 mm					00076900
			10	HB	
67 mm					00076901
			10	HB	
72 mm					00076902
			10	HB	
77 mm					00076903
			10	HB	
82 mm					00076904
			10	HB	



hama

Lens filter
"Gray Filter Vario DC ND-2400, DC Double Coated"

Coating	Coated
Metal Mount	Black
Mount Thickness	7 mm
Type	Grey Filter
Type of Glass	High-Grade Lens Glass

- Possibility to lengthen the exposure time between +1 and +8 (ND2-400) aperture stops
- Rotary mount for individual adjustment
- Coating: one layer on each side
- Quality standard (glass): high-quality lens glass

Impact on the pictures:

- Allows large apertures e.g. when shooting portraits when it is extremely bright: due to a blurred background the photographed person is clearly visible in the foreground

40.5 mm					00079141
49 mm					00079149
52 mm					00079152
			10	BK	
55 mm					00079155
			9	BK	
58 mm					00079158
			9	BK	
62 mm					00079162
			10	BK	
67 mm					00079167
			6	BK	
72 mm					00079172
			6	BK	
77 mm					00079177
			9	BK	
82 mm					00079182
			10	BK	



hama

Lens filter
"Polarization Filter Profi Line, circular, NMC16 Nano"

Coating	NMC16 (Nano Multi-Coated 16-fold)
Metal Mount	Black
Mount Thickness	4.5 mm
Type	Polarization Filter
Type of Glass	High-Grade Lens Glass

- Enhances contrast and brings depth to the picture, e.g. the sky becomes a strong blue, clouds become artificially white, colours are clearer and more intense
- Depending on the filter setting, the contrast and depth vary and non-metallic reflections (water, plastic, glass, etc.) are removed
- Maximum effectiveness with a photographic angle of 30-40° to the reflecting surface
- Ultra-flat and ultra-lightweight rotary mount for variable settings

37 mm					00077100
49 mm					00077101
52 mm					00077102
55 mm					00077103
			6	HB	
58 mm					00077104
62 mm					00077105
			6	HB	
67 mm					00077106
			6	HB	
77 mm					00077108
			6	HB	
82 mm					00077109
			6	HB	
72 mm					00077107
			6	HB	



hama

Lens filter
"Polarization Filter AR, circular, multi-coated"

Coating	AR Coated (4x)
Metal Mount	Black
Mount Thickness	6 mm
Type	Polarization Filter
Type of Glass	High-Grade Lens Glass

- Neutral colour
- AR coating: two layers on each side, for better light transmission
- Quality standard (glass): high-quality lens glass
- Rotary mount with a pin

Impact on the pictures:

- Puts contrast and depth in the picture, the sky gets blue, clouds get white and colours become clearer and brighter

37 mm					00072537
49 mm					00072549
			10	SC	
52 mm					00072552
			10	SC	
55 mm					00072555
			10	SC	
58 mm					00072558
			9	SC	
62 mm					00072562
			10	SC	
67 mm					00072567
			10	SC	
72 mm					00072572
			10	SC	
77 mm					00072577
			10	SC	
82 mm					00072582
			10	SC	



hama

Lens filter "Protect filter „Ultimate“, MC8, Wide"

Coating	MC8 (8x Multi-Coated)
Metal Mount	Black
Mount Thickness	2.4 mm
Type	Protection Filter
Type of Glass	Optical Glass

- MC8 coating: four layers on each side, for excellent permeability to light and maximum anti-reflective properties
- Vapour-deposited, multi-layer coating
- Scratch-resistant
- Filter front and back are coated, ensuring no loss of contrast or brilliance and preventing ghosting and double images
- Ultra-thin, wide mount: prevents vignetting, can remain on the lens permanently
- Barely increases the lens front section
- A protected front lens saves expensive repair costs
- Quality class (glass): optical glass

37 mm	00071300
49 mm	00071301
	6 HB
52 mm	00071302
	6 HB
55 mm	00071303
	6 HB
58 mm	00071304
	6 HB
62 mm	00071305
	6 HB
67 mm	00071306
	6 HB
72 mm	00071307
	6 HB
77 mm	00071308
	6 HB



hama

Lens filter "UV Protection Filter Premi- um 390, Wide, NSC18 Nano"

Coating	NSC18 (Nano Super-Coated 18-fold)
Metal Mount	Black
Mount Thickness	2.9 mm
Type	UV Protection Filter
Type of Glass	High-Grade Lens Glass

- Block UV rays up to 390 nm
- Especially clear, sharp pictures with brilliant colours since the unwanted blue colouring of ultra-violet radiation is avoided, reducing haze and preventing blurring
- NSC18 coating: nine layers on each side, for excellent permeability to light and maximum anti-reflective properties
- Vapour-deposited nano-coating

40.5 mm	00071500
46 mm	00071501
	6 HB
49 mm	00071502
	6 HB
52 mm	00071503
	6 HB
55 mm	00071504
	6 HB
58 mm	00071505
	6 HB
62 mm	00071506
	6 HB
67 mm	00071507
	6 HB
72 mm	00071508
	6 HB
77 mm	00071509
	6 HB
82 mm	00071510
	6 HB



hama

Lens filter "UV Protection Filter Profi Line, Wide, NMC 16 Nano"

Coating	NMC16 (Nano Multi-Coated 16-fold)
Metal Mount	Black
Mount Thickness	2.4 mm
Type	UV Protection Filter
Type of Glass	High-Grade Lens Glass

- Clear pictures with brilliant colours since the unwanted blue colouring of ultra-violet radiation is avoided, reducing haze and preventing blurring

37 mm	00071400
40.5 mm	00071401
43 mm	00071402
46 mm	00071403
49 mm	00071404
	6 HB
52 mm	00071405
	6 HB
55 mm	00071406
	6 HB
58 mm	00071407
	6 HB
62 mm	00071408
	6 HB
67 mm	00071409
	6 HB
72 mm	00071410
	6 HB
77 mm	00071411
	6 HB
82 mm	00071412
	6 HB
95 mm	00071413
	10 HB
105 mm	00071414
	10 HB



hama

Lens filter "UV-Protection Filter AR-4"

Coating	AR Coated
Metal Mount	Black
Mount Thickness	5 mm
Type	UV Protection Filter
Type of Glass	High-Grade Lens Glass

- Neutral colour
- AR coating: two layers on each side, for better light transmission
- Quality standard (glass): high-quality lens glass

- Impact on the pictures:
- Clear, sharp photos
 - Reduces haze and prevents fuzziness

37 mm	00070137
40.5 mm	00070141
43 mm	00070143
	9 SC
46 mm	00070146
	10 SC
49 mm	00070149
	9 SC
52 mm	00070152
	10 SC
55 mm	00070155
	10 SC
58 mm	00070158
	10 SC
62 mm	00070162
	10 SC
67 mm	00070167
	10 SC
72 mm	00070172
	10 SC
77 mm	00070177
	10 SC



hama

**Lens filter
"UV Protection Filter DC
Double Coated"**

Coating	Coated
Metal Mount	Black
Mount Thickness	3.4 mm
Type	UV Protection Filter
Type of Glass	Optical Glass

- Neutral colour
- Coating: one layer on each side
- Quality standard (glass): optical glass

- Impact on the pictures:
- Clear, sharp photos
 - Reduces haze and prevents fuzziness

37 mm	00070037
49 mm	00070049
	10 SC
52 mm	00070052
	10 SC
55 mm	00070055
	9 SC
58 mm	00070058
	10 SC
62 mm	00070062
	10 SC
67 mm	00070067
	10 SC
72 mm	00070072
	10 SC
77 mm	00070077
	10 SC

Adapter Ring



hama

**Adapter Ring
"For 37 mm Lens"**

Shade of colour	Black
Camera/Lens Thread	37 mm

- Adapter for all lenses and attachments with screw thread
- Precision metal rings with matt black surface

37 mm	00013737
43 mm	00013743
46 mm	00013746
52 mm	00013752
	12 BK



hama

**Filter Adapter Ring, Lens 30.0
mm/Filter 37.0 mm**

Shade of colour	Black
Camera/Lens Thread	30 mm

- Adapter for all lenses and attachments with screw thread
- Precision metal rings with matt black surface

37 mm	00013137
	12 BK



hama

**Filter Adapter Ring, Lens 30.5
mm/Filter 37.0 mm**

Shade of colour	Black
Camera/Lens Thread	30.5 mm

- Adapter for all lenses and attachments with screw thread
- Precision metal rings with matt black surface

37 mm	00013037
	12 BK



hama

**Adapter Ring
"For 43 mm Lens"**

Shade of colour	Black
Camera/Lens Thread	43 mm

- Adapter for all lenses and attachments with screw thread
- Precision metal rings with matt black surface

46 mm	00014346
49 mm	00014349
52 mm	00014352
	12 BK



hama

**Adapter Ring
"For 52 mm Lens"**

Shade of colour	Black
Camera/Lens Thread	52 mm

- Adapter for all lenses and attachments with screw thread
- Precision metal rings with matt black surface

49 mm	00015249
55 mm	00015255
58 mm	00015258
72 mm	00015272
	12 BK



hama

**Adapter Ring
"For 58 mm Lens"**

Shade of colour	Black
Camera/Lens Thread	58 mm

- Adapter for all lenses and attachments with screw thread
- Precision metal rings with matt black surface

49 mm	00015849
52 mm	00015852
55 mm	00015855
62 mm	00015862
72 mm	00015872
	12 BK



hama

**Adapter Ring
"For 55 mm Lens"**

Shade of colour	Black
Camera/Lens Thread	55 mm

- Adapter for all lenses and attachments with screw thread
- Precision metal rings with matt black surface

52 mm	00015552
58 mm	00015558
62 mm	00015562
72 mm	00015572
	12 BK



hama

**Adapter Ring
"For 49 mm Lens"**

Shade of colour	Black
Camera/Lens Thread	49 mm

- Adapter for all lenses and attachments with screw thread
- Precision metal rings with matt black surface

58 mm	00014958
62 mm	00014962
	12 BK



hama

**Adapter Ring
"For 67 mm Lens"**

Shade of colour	Black
Camera/Lens Thread	67 mm

- Adapter for all lenses and attachments with screw thread
- Precision metal rings with matt black surface

62 mm	00016762
77 mm	00016777
	12 BK



hama

**Adapter Ring
"For 77 mm Lens"**

Shade of colour	Black
Camera/Lens Thread	77 mm

- Adapter for all lenses and attachments with screw thread
- Precision metal rings with matt black surface

72 mm	00017772
82 mm	00017782
	11 BK



hama

**Adapter Ring
"For 46 mm Lens"**

Shade of colour	Black
Camera/Lens Thread	46 mm

- Adapter for all lenses and attachments with screw thread
- Precision metal rings with matt black surface

55 mm	00014655
	12 BK



hama

**Adapter Ring
"For 62 mm Lens"**

Shade of colour	Black
Camera/Lens Thread	62 mm

- Adapter for all lenses and attachments with screw thread
- Precision metal rings with matt black surface

58 mm	00016258
67 mm	00016267
72 mm	00016272
	12 BK



hama

**Adapter Ring
"For 72 mm Lens"**

Shade of colour	Black
Camera/Lens Thread	72 mm

- Adapter for all lenses and attachments with screw thread
- Precision metal rings with matt black surface

67 mm	00017267
	12 BK

Picture Frames

Clips/Clamp



hama

2 Filter Clamps, 49 - 58 cm

Shade of colour	Black
Material	Plastic Material
Weight	5 g

- For filters or other screwable lens attachments with a diameter between 49 and 58 mm

00005896

6 BK

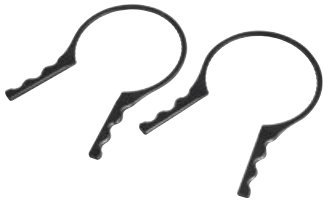

hama

2 Filter Clamps, 62 - 86 mm

Shade of colour	Black
Material	Plastic Material
Weight	9 g

- For filters or other screwable lens attachments with a diameter between 62 and 86 mm

00005897

6 BK

FILTER & ACCESSORIES

Accessories for Lenses



Lid



hama

Lid
"Smart snap, with holder"

Shade of colour	Black
-----------------	-------

- Snap function for quick and secure attachment to the filter thread of a lens
- Retaining cord for securing to a camera and lens
- Internal handle for easy handling- Can also be used with filters- For lenses with 37 mm front filter thread

37 mm	00095400
40.5 mm	00095438
43 mm	00095442
46 mm	00095447
49 mm	00095450
52 mm	00095453
55 mm	00095456
58 mm	00095459
	50 HB
62 mm	00095463
67 mm	00095468
72 mm	00095473
	50 HB
77 mm	00095478
82 mm	00095483
	50 HB

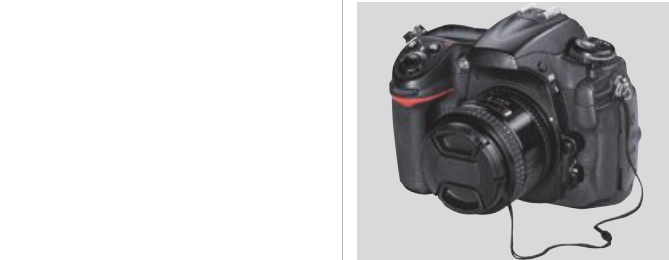

hama

Lid
"Super-Snap"

Shade of colour	Black
-----------------	-------

- Snap function for quick and secure attachment to the filter thread of a lens
- Clamp mechanism integrated in the surface of the lid
- Cannot be removed via the outer edge therefore suitable for secure transportation in bags
- Without any bulky overhang
- Can also be attached to filters

37 mm	00094437
	12 BK



hama

Lid
"Smart-Snap"

Shade of colour	Black
-----------------	-------

- Snap function for quick and secure attachment to the filter thread of a lens
- Retaining cord for securing to a camera and lens
- Can also be attached to filters

40.5 mm	00095441
	20 BK

Protection



hama

Lens Cap Holder

Shade of colour	Black
Material	Plastic Material/ Rubber

- The elastic band allows attachment to all lens diameters
- The elastic loop stretches around the lens
- The adhesive pad is attached to the lens cap
- For permanently attaching to the lens cap
- The thin elastic loop blends in with the camera's design

			00005898
	8	BK	



hama

Lens Cap Holder

Shade of colour	Black
Material	Rubber

- With a snap hook for attaching to the hand strap's eye
- The adhesive pad is attached to the lens cap
- For permanently attaching to the lens cap

			00005899
	8	BK	

Lens Pouch/Bag



hama

**Lens Pouch/Bag
"Neoprene", Black**

Material	Neoprene
----------	----------

- Snap hook for attachment to camera bag, belt or back pack
- Elastic cord with quick-release buckle for rapid removal of the lens
- Flexible neoprene material for protection against shocks
- Belt loops
- Suitable for lenses with a diameter up to 100 mm and height of up to 170 mm

50 mm				00126693
		10	HC	
80 mm				00126694
		10	HC	
130 mm				00126695
		10	HC	
170 mm				00126696
		15	HC	

Lens hood



hama

**Lens hood
"Snap with Lens Cap for Wide
Angle Lenses"**

Shade of colour	Black
-----------------	-------

- The rotating lens hood blocks light coming in from the side in any desired position
- Snap function for quick and secure attachment of a lens hood and cap to the filter thread of a lens
- For space-saving transport simply put the lens hood on the lens the other way round
- For wide-angle and wide-angle zoom lenses
- Optimized for modern digital lenses
- The matt-finished inner surface avoids reflections
- In addition to the filter, the plastic lens hood provides protection against impacts
- Universally suitable

77 mm				00093677
		10	BK	
67 mm				00093667
72 mm				00093672
		10	BK	
62 mm				00093662
		10	BK	
58 mm				00093658
		10	BK	
52 mm				00093652
55 mm				00093655
		10	BK	



hama

**Lens hood
"ST for standard lenses, fold-
able, New"**

Shade of colour	Black
-----------------	-------

- Foldable for space-saving transportation
- For standard lenses (from focal length of 45 mm) and digital cameras with inner thread (screw-in frame: diam. 37.0 mm)
- Allows a 37.0 mm filter to be attached to the lens hood
- Inner surface of the lens hood has a matt finish to prevent reflections

77 mm				00093350
		10	HB	
72 mm				00093347
		10	HB	
67 mm				00093344
		10	HB	
58 mm				00093340
62 mm				00093342
		10	HB	
37 mm				00093300
40.5 mm				00093303
46 mm				00093325
49 mm				00093332
52 mm				00093336
		10	HB	
55 mm				00093338
		10	SC	

Camera Accessories

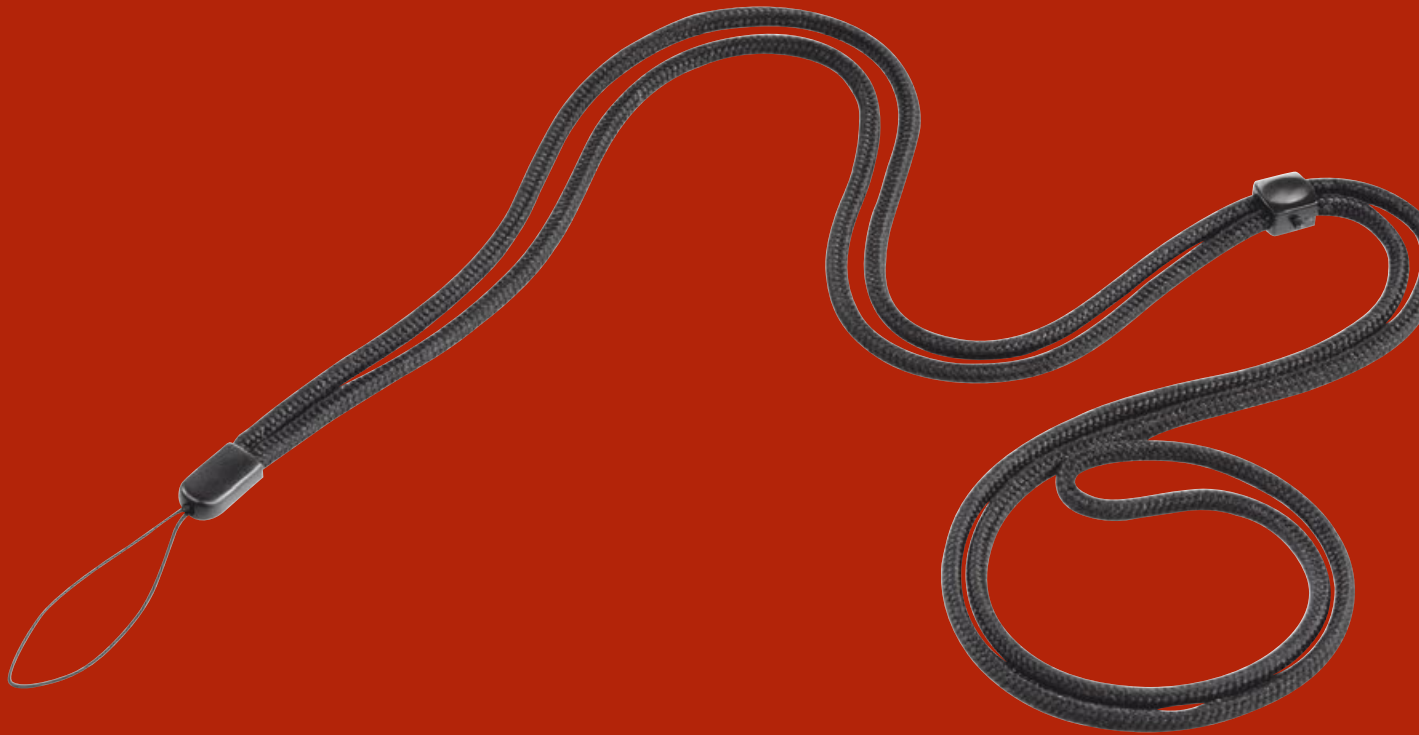

Straps and hand straps

Carrying Strap



hama

"2in1 130" Camera Carrying Strap, neoprene, straight, black

Shade of colour	Black
Material	Neoprene
Maximum Length	130 cm

- The ends of the strap are removable at the quick release fastener and function as a separate carrying loop for a camera
- Straight strap, especially durable thanks to super elastic neoprene
- Bottom side with a rubber-coated, non-slip structure
- With a round split ring, especially suited for fixing to older camera models
- Adjustable length: 90 - 130 cm



hama

"Braid 120" Camera Strap, Quick Fastener, Length 120 cm, black

Shade of colour	Black
Material	Nylon
Maximum Length	120 cm

- Snow, rain or sun: weather-resistant nylon is suitable for all weathers
- Retro design in trendy woven look
- Elastic camera strap made from tear-resistant nylon is pleasant to carry
- Can be used for all cameras with eyelets
- Simply separate the camera from the strap via the quick fastener



hama

"Braid 120" Camera Strap, Quick Fastener, Length 120 cm, black/yellow

Shade of colour	Black, Yellow
Material	Nylon
Maximum Length	120 cm

- Snow, rain or sun: weather-resistant nylon is suitable for all weathers
- Retro design in trendy woven look
- Elastic camera strap made from tear-resistant nylon is pleasant to carry
- Can be used for all cameras with eyelets
- Simply separate the camera from the strap via the quick fastener



hama

"Braid 120" Camera Strap, Quick Fastener, Length 120 cm, orange/blue

Shade of colour	Blue, Orange
Material	Nylon
Maximum Length	120 cm

- Snow, rain or sun: weather-resistant nylon is suitable for all weathers
- Retro design in trendy woven look
- Elastic camera strap made from tear-resistant nylon is pleasant to carry
- Can be used for all cameras with eyelets
- Simply separate the camera from the strap via the quick fastener

CAMERA ACCESSORIES

00027202	
6	BK

00027212	
50	HB

00027213	
50	HB

00027214	
50	HB

Straps and hand straps | Protective Films/Glasses

Hand Strap



hama

Handle Loop, Textile, 22 cm, black

Material	Plastic Material
----------	------------------

- Can be used universally for all compact cameras, also suitable for MP3 players, USB sticks, etc. with eyelet
- Tear-resistant and robust woven structure
- Adjustable for optimised grip at the hand and wrist

Black	00027836
288	HB



hama

Carrying Loop, Textile, 65 cm, black

Material	Nylon
----------	-------

- Can be used universally for all compact cameras, also suitable for MP3 players, USB sticks, etc. with eyelet
- Tear-resistant and robust woven structure

Black	00027837
8	HB

Split Ring



hama

Split Rings, square, 6 pieces

- Triangular shape, especially suited for fixing to older camera models

00027902	
8	HB

Screen Protector



hama

"Premium" EASY-ON® Universal Screen Protector, displays up to 14 cm (5.5")

- Extremely scratch-resistant, acid-proof, antistatic and washable screen protector with 4-layer technology
- True colour reproduction on the display ensures brilliant colours
- EASY-ON®: fixing aids for easy attachment of the protective film
- Universal fit for all digital cameras, mobile phones, MP3 players and navigation systems with a screen size of up to 14 cm (5.5")

00001210	
25	HC



hama

Carrying Loop with Quick Fastener, 45 cm, black

Material	Nylon
----------	-------

- Can be used universally for all compact cameras, also suitable for MP3 players, USB sticks, etc. with eyelet
- 2-piece: separate the camera from the strap via the quick fastener
- Tear-resistant and robust woven structure

Black	00027838
8	HB



hama

Hand Strap "Braid 20, quick release, length 20 cm"

Material	Polyester
----------	-----------

- Snow, rain or sun: weather-resistant polyester is suitable for all weathers
- Retro design in trendy woven look
- Made from very lightweight and soft polyester, therefore pleasant to carry
- Can be used for all cameras with eyelets
- The camera can be easily separated from the strap via the quick fastener

Black, Orange	00027217
Black	00027215
Black, Yellow	00027216
50	HB



hama

"Premium" EASY-ON® Universal Screen Protectors, displays up to 7.62cm (3.0")

- Extremely scratch-resistant, acid-proof, antistatic and washable screen protector with 4-layer technology
- True colour reproduction on the display ensures brilliant colours
- Precision laser cut for a perfect fit and contour precision
- EASY-ON®: fixing aids for easy attachment of the protective film
- Universal fit for all digital cameras, mobile phones, MP3 players and navigation systems

00001211	
25	HC

CAMERA ACCESSORIES

Protection Hoods | Remote Control Releases

CAMERA ACCESSORIES



Lid

hama

Body Cap for NEX/Sony

Shade of colour	Black
-----------------	-------

- Suitable for NEX/Sony DSLR cameras

00030140		
12	BK	



hama

Body Cap for Nikon

Shade of colour	Black
-----------------	-------

- Suitable for all Nikon SLR and DSLR cameras

00030102		
12	BK	



hama

Housing Cover for Nikon Z

Shade of colour	Black
-----------------	-------

- Suitable for all Nikon Z cameras

00030141		
12	BK	



Release

hama

"Professional" Wire Release, 40 cm

Shade of colour	Black
Length	40 cm

- Bulb function for shake-free long-term exposures
- Easy to place in position by means of the lock, ideal for time exposures (bulb)
- Ergonomically shaped handle allows easy release

00005312		
6	BK	

00030141		
12	BK	

HDMI™-Cable



hama

HDMI™-Cable "High Speed Type A/D (Micro)"

Shade of colour	Black
Data Transfer Rate	18 Gbit/s
Max. Resolution	4k (4096 x 2160)
Version	High Speed with Ethernet

- Gold-plated plugs with low contact resistance for secure signal transmission
- Fully shielded audio and video lines for optimum reduction of electromagnetic interference
- Integrated channel for transmitting network data with up to 100 Mbit/s
- 3D transmission due to extended bandwidth
- Return of the audio signal without additional audio cable (ODT, RCA etc.)
- For connecting devices with HDMI™ type A connection to devices with HDMI™ type D (micro) socket
- Image resolution: 3840 x 2160 - 24 Hz/25 Hz/30 Hz/50 Hz/60Hz, 4096 x 2160 - 24 Hz
- Colour space: 30/36/48 bits
- Transmission of the following audio data: 8PCM, Dolby Digital, DTS, MPEG, DVD-Audio, SACD, Dolby Digital Plus, True HD, dts-HD
- Transmission of the type of player via ACE (Automatic Content Enhancement)
- HDMI™ CEC support (Consumer Electronics Control)
- High-speed transmission of up to 18 Gbit/s for all image and sound standards with a bandwidth of 600 MHz and more

0.5 m					00074239
		6	BK		
2 m					00074240
		6	BK		



hama

High-Speed HDMI™ Cable, Plug - Plug, Ethernet, 1.5 m + HDMI™ Adapter

Shade of colour	Black
Data Transfer Rate	18 Gbit/s
Max. Resolution	4k (4096 x 2160)
Version	High Speed with Ethernet

- 3in1 connection for connecting every camera to a TV and a PC/notebook to a TV
- Gold-plated plug with low contact resistance for secure signal transmission
- Integrated channel for transmitting network data with up to 100 Mbit/s
- 3D transmission due to extended bandwidth
- Fully shielded audio and video lines for optimum reduction of electromagnetic interference
- Return of the audio signal without additional audio cable (ODT, RCA etc.)
- HDMI™ cable for perfect, high-resolution ultra HD cinema quality 4096x2160 (4k) pixels
- Image resolution: 3840 x 2160 - 24 Hz/25 Hz/30 Hz/50 Hz/60Hz, 4096 x 2160 - 24 Hz
- Colour space: 30/36/48 bit
- Transmission of the following audio data: 8PCM, Dolby Digital, DTS, MPEG, DVD-Audio, SACD, Dolby Digital Plus, True HD, dts-HD
- Transmission of the type of player via ACE (Automatic Content Enhancement)
- HDMI™ CEC support (Consumer Electronics Control)
- High speed transmission of up to 18 Gbit/s for all image and sound standards from a bandwidth of 600 MHz

1.5 m					00074242
		6	BK		



hama

HDMI™-Cable "High Speed Type A/C (Mini)"

Shade of colour	Black
Data Transfer Rate	18 Gbit/s
Max. Resolution	4k (4096 x 2160)
Version	High Speed with Ethernet

- Gold-plated plugs with low contact resistance for secure signal transmission
- Fully shielded audio and video lines for optimum reduction of electromagnetic interference
- Integrated channel for transmitting network data with up to 100 Mbit/s
- 3D transmission due to extended bandwidth
- Return of the audio signal without additional audio cable (ODT, RCA etc.)
- Supports automatic video/audio synchronization of HDMI™ devices
- Colour resolution: 3840 x 2160 - 24 Hz/25 Hz/30 Hz/50 Hz/60 Hz, 4096 x 2160 - 24 Hz
- Transmission of the following audio data: 8PCM, Dolby Digital, DTS, MPEG, DVD-Audio, SACD, Dolby Digital Plus, True HD, dts-HD
- High-speed transmission of up to 18 Gbit/s for all image and sound standards with a bandwidth of 600 MHz and more
- Extended colour space

2 m					00074229
		6	BK		



hama

High-Speed HDMI™ Cable, Plug Type-A - Plug Type-C (Mini), Ethernet, 2 m

- Gold-plated plug with low contact resistance for secure signal transmission
- High-quality materials and shielded lines for excellent picture and sound quality without interference
- Integrated channel for transmitting network data with up to 100 Mbit/s
- 3D transmission due to extended bandwidth
- Return of the audio signal without additional audio cable (ODT, RCA etc.)
- Supports automatic video/audio synchronization of HDMI™ devices
- Image resolution: 3840 x 2160 - 24 Hz/25 Hz/30 Hz/50 Hz/60 Hz, 4096 x 2160 - 24 Hz
- Transfer of 8PCM, Dolby Digital, DTS, MPEG, DVD audio, SACD, Dolby Digital Plus, True HD and dts-HD audio data
- High-speed transmission of up to 18 Gbit/s for all image and sound standards from a bandwidth of 600 MHz
- Extended colour space

2 m					00074258
		6	HB		

Cables & Adapters

CAMERA ACCESSORIES



hama

High-Speed HDMI™ Cable, Plug Type-A - Plug Type-D (Micro), Ethernet, 2 m

- HDMI™ cable for perfect, high-resolution ultra HD cinema quality 4096x2160 (4k) pixels
- High-quality materials and shielded lines for excellent picture and sound quality without interference
- Integrated channel for transmitting network data with up to 100 Mbit/s
- 3D transmission due to extended bandwidth
- Return of the audio signal without additional audio cable (ODT, RCA etc.)
- Gold-plated plug with low contact resistance for secure signal transmission
- For connecting devices with an HDMI™ Type-A connection to devices with an HDMI™ Type-D (micro) socket
- Image resolution: 3840 x 2160 - 24 Hz/25 Hz/30 Hz/50 Hz/60 Hz, 4096 x 2160 - 24 Hz
- Colour space: 30/36/48 bit
- Transfer of 8PCM, Dolby Digital, DTS, MPEG, DVD audio, SACD, Dolby Digital Plus, True HD and dts-HD audio data
- Transmission of the type of player via ACE (Automatic Content Enhancement)
- HDMI™ CEC support (Consumer Electronics Control)
- High-speed transmission of up to 18 Gbit/s for all image and sound standards from a bandwidth of 600 MHz

2 m	00074259
40 HB	



hama

Micro USB Cable, gold-plated, twist-proof, black, 0.75 m

Quality	3 Stars
Connection	Micro-USB-Plug, USB Micro B Plug, USB-Typ-A-Plug
USB Standard	USB 2.0

- High-speed data transfer of up to 480 Mbps
- Gold-plated plug with low contact resistance for secure signal transmission
- The inner conductor is made of copper which ensures best transmission properties
- Light and space-saving due to the ultra thin, flexible cable and the extra small plugs
- Slim design especially suited for portable devices like smartphones, tablets and cameras
- No bothersome trying out: the plug can be inserted without having to be turned
- Sturdy plugs and moulded strain reliefs, high mechanical resistance
- Twisted data lines (twisted pairs)
- Ideal for charging, data transfer and synchronisation
- Also called "reversible micro USB"

0.75 m	00074251
12 BK	



hama

"Flexi-Slim" Micro-USB Cable, USB 2.0, 480 Mbit/s, 0.75 m

Quality	Standard
Connection	Micro-USB-Plug, USB-Typ-A-Plug
USB Standard	USB 2.0

- High-speed data transfer of up to 480 Mbps
- Light and space-saving due to the ultra thin, flexible cable and the extra small plugs
- Gold-plated plug with low contact resistance for secure signal transmission
- Flexible materials guarantee optimum kink protection and prevent cable breakage
- High-quality materials and workmanship guarantee excellent transmission quality
- Twisted data pairs with an outer sheath made from robust PVC material minimise interference
- Internal wires made from copper for rapid data transfer and the best supply of power
- Ideal for charging, transferring data and synchronising
- Also known as a "Reversible Micro-USB"
- also as a replacement for the original cable if it is too short, long or faulty

0.75 m	00074264
12 BK	



hama

"Flexi-Slim" Mini-USB Cable, Mini-B5 connector, USB 2.0, 480 Mbit/s, 0.75 m

Quality	Standard
Connection	USB Mini B Plug, USB-Typ-A-Plug
USB Standard	USB 2.0

- High-speed data transfer of up to 480 Mbps
- Light and space-saving due to the ultra thin, flexible cable and the extra small plugs
- Gold-plated plug with low contact resistance for secure signal transmission
- Flexible materials guarantee optimum kink protection and prevent cable breakage
- High-quality materials and workmanship guarantee excellent transmission quality
- Twisted data pairs with an outer sheath made from robust PVC material minimise interference
- Internal wires made from copper for rapid data transfer and the best supply of power
- Ideal for charging, transferring data and synchronising
- also as a replacement for the original cable if it is too short, long or faulty

0.75 m	00074262
12 BK	



hama

"Flexi-Slim" Mini-USB cable, Mini-B8 connector, USB 2.0, 480 Mbit/s, 0.75 m

Quality	Standard
Connection	USB mini B8 connector, USB-Typ-A-Plug
USB Standard	USB 2.0

- High-speed data transfer of up to 480 Mbps
- Light and space-saving due to the ultra thin, flexible cable and the extra small plugs
- Gold-plated plug with low contact resistance for secure signal transmission
- Flexible materials guarantee optimum kink protection and prevent cable breakage
- High-quality materials and workmanship guarantee excellent transmission quality
- Twisted data pairs with an outer sheath made from robust PVC material minimise interference
- Internal wires made from copper for rapid data transfer and the best supply of power
- Ideal for charging, transferring data and synchronising
- also as a replacement for the original cable if it is too short, long or faulty

0.75 m	00074263
12	BK



hama

"Flexi-Slim" USB-A to USB-C cable, USB 2.0, 480 Mbit/s, 0.75 m

Quality	Standard
Connection	USB-C-plug, USB-Typ-A-Plug
USB Standard	USB 2.0

- High-speed data transfer of up to 480 Mbps
- Light and space-saving due to the ultra thin, flexible cable and the extra small plugs
- Gold-plated plug with low contact resistance for secure signal transmission
- Flexible materials guarantee optimum kink protection and prevent cable breakage
- High-quality materials and workmanship guarantee excellent transmission quality
- Twisted data pairs with an outer sheath made from robust PVC material minimise interference
- Internal wires made from copper for rapid data transfer and the best supply of power
- Ideal for charging, transferring data and synchronising
- also as a replacement for the original cable if it is too short, long or faulty

0.75 m	00074265
12	BK



hama

Mini-USB Cable, mini-B5 connector, USB 2.0, 480 Mbit/s, 1.50 m

Quality	Standard
Connection	USB Mini B Plug, USB-Typ-A-Plug
USB Standard	USB 2.0

- High-speed data transfer of up to 480 Mbps
- Additional shielding for good reduction of electromagnetic interference
- Flexible materials guarantee optimum kink protection and prevent cable breakage
- High-quality materials and workmanship guarantee excellent transmission quality
- Twisted data pairs with an outer sheath made from robust PVC material minimise interference
- Internal wires made from copper for rapid data transfer and the best supply of power
- Ideal for charging, transferring data and synchronising
- also as a replacement for the original cable if it is too short, long or faulty

1.5 m	00074260
6	HB



hama

Mini-USB Cable, Mini-B8 connector, USB 2.0, 480 Mbit/s, 1.50 m

Quality	Standard
Connection	USB mini B8 connector, USB-Typ-A-Plug
USB Standard	USB 2.0

- High-speed data transfer of up to 480 Mbps
- Additional shielding for good reduction of electromagnetic interference
- Flexible materials guarantee optimum kink protection and prevent cable breakage
- High-quality materials and workmanship guarantee excellent transmission quality
- Twisted data pairs with an outer sheath made from robust PVC material minimise interference
- Internal wires made from copper for rapid data transfer and the best supply of power
- Ideal for charging, transferring data and synchronising
- also as a replacement for the original cable if it is too short, long or faulty

1.5 m	00074261
6	HB



hama

USB 2.0 Connection Cable, A-plug - mini B plug (B8 pin), 1.8 m, black

Quality	Standard
Connection	USB Mini B Plug, USB-Typ-A-Plug
USB Standard	USB 2.0

- High-speed data transfer of up to 480 Mbps
- USB 2.0 (downward compatible)
- High-density shielding due to tinned copper strands, fully excludes disturbing radiation/emittance

1.8 m	00074204
6 BK	



hama

"Flexi-Slim" USB-C to USB-C cable, USB 2.0, 480 Mbit/s, 0.75 m

Quality	Standard
Connection	USB-C-plug
USB Standard	USB 2.0

- High-speed data transfer of up to 480 Mbps
- Light and space-saving due to the ultra thin, flexible cable and the extra small plugs
- Gold-plated plug with low contact resistance for secure signal transmission
- Flexible materials guarantee optimum kink protection and prevent cable breakage
- High-quality materials and workmanship guarantee excellent transmission quality
- Twisted data pairs with an outer sheath made from robust PVC material minimise interference
- Internal wires made from copper for rapid data transfer and the best supply of power
- Ideal for charging, transferring data and synchronising
- Also as a replacement for the original cable if it is too short, long or faulty

0.75 m	00074266
12 BK	

Video Converter



hama

Video Recording Stick, USB Plug - HDMI™ Socket, 4K

Connection	HDMI™ Socket, USB-Typ-A-Plug
------------	------------------------------

- Fluid video recordings without delays or distortions during live streaming thanks to a picture frequency of 60 Hz and 1080p with Full HD
- Transform high-quality video cameras into a high-resolution USB web camera and use it in various apps without additional software
- High-quality and sturdy aluminium housing in a sophisticated design

00074257
6 HB

Microphone



hama

"RMN Uni" Directional Microphone, for Accessory Shoe

Shade of colour	Black
Connection	3.5 mm Jack Plug
Directivity	Uni-directional
Model	Mono
Cable Length	0.32 m

- From smartphones to camcorders - for bloggers or film-makers: the microphone is ideal for all devices
- The vibration-attenuating anti-shock frame absorbs mechanical vibration and noise

00004647
10 HB



hama

"Smart" Lavalier Microphone

Shade of colour	Black
Connection	3.5 mm Jack Plug
Directivity	omni-directional
Model	Mono
Cable Length	6 m

- From smartphones to camcorders - for bloggers or film-makers: the microphone is ideal for all devices

00004634
6 HB

Camera Lens Adapter



hama

Lens Adapter for Cameras with T2 Connection and Canon EOS Lenses

Black			00030743
	11	BK	

Spirit Level



hama

Camera Spirit Level, 2 bubble levels

Number of Bubble Levels	2
-------------------------	---

- For adjusting the camera for portrait and landscape shots
- Transparent housing
- Is inserted into the camera's hot shoe (standard flash shoe), can also be connected via a flash bracket
- 2 feet to position the camera for upright and broadside shots
- 2 bubble levels for precise adjustment

			00005411
	6	BK	



hama

Lens Adapter for Cameras with C-Mount Connection to Nikon Lenses

Black			00030770
	6	BK	

Energy



Rechargeable Batteries & Powerpacks

Replacement battery



hama

"DP 553" Lithium Ion Battery for Canon LP-E6

Shade of colour	Black
Capacity	1500 mAh
Voltage	7.2 V
Model	Li-Ion

- Use with UL/IEC-certified branded cells: for increased safety
- Safety electronics: for monitoring of the charging and discharge process
- Gold-plated contacts: for fewer contact losses and prevention of corrosion
- Self-resetting thermal fuse (Polyswitch/PTC): additional protection against short circuits and overload

00077553	
6	HB



hama

"DP 396" Lithium Ion Battery for Canon LP-E10

Shade of colour	Black
Capacity	950 mAh
Voltage	7.4 V
Model	Li-Ion

- Use with UL/IEC-certified branded cells: for increased safety
- Safety electronics: for monitoring of the charging and discharge process
- Gold-plated contacts: for fewer contact losses and prevention of corrosion
- Self-resetting thermal fuse (Polyswitch/PTC): additional protection against short circuits and overload

00077511	
6	HB



hama

"DP 219" Li-Ion Battery for Canon NB-2L/H

Capacity	700 mAh
Voltage	7.4 V
Model	Li-Ion

- Use with UL/IEC-certified branded cells: for increased safety
- Safety electronics: for monitoring of the charging and discharge process
- Gold-plated contacts: for fewer contact losses and prevention of corrosion
- Self-resetting thermal fuse (Polyswitch/PTC): additional protection against short circuits and overload

00077529	
6	HB



hama

"DP 437" Lithium Ion Battery for Canon NB-11L

Shade of colour	Black
Capacity	580 mAh
Voltage	3.6 V
Model	Li-Ion

- Use with UL/IEC-certified branded cells: for increased safety
- Safety electronics: for monitoring of the charging and discharge process
- Gold-plated contacts: for fewer contact losses and prevention of corrosion
- Self-resetting thermal fuse (Polyswitch/PTC): additional protection against short circuits and overload

00077520	
6	HB

ENERGY



hama

"DP 554" Lithium Ion Battery for Canon LP-E8

Shade of colour	Grey
Capacity	1020 mAh
Voltage	7.4 V
Model	Li-Ion

- Use with UL/IEC-certified branded cells: for increased safety
- Safety electronics: for monitoring of the charging and discharge process
- Gold-plated contacts: for fewer contact losses and prevention of corrosion
- Self-resetting thermal fuse (Polyswitch/PTC): additional protection against short circuits and overload

00077554	
6	HB



hama

"DP 543" Lithium Ion Battery for Canon LP-E12

Shade of colour	Black
Capacity	700 mAh
Voltage	7.2 V
Model	Li-Ion

- Use with UL/IEC-certified branded cells: for increased safety
- Safety electronics: for monitoring of the charging and discharge process
- Gold-plated contacts: for fewer contact losses and prevention of corrosion
- Fixation of the cells thanks to super-adhesive tape: for improved resistance to impacts and mechanical protection

00077543	
6	HB



hama

"DP 546" Lithium Ion Battery for Canon NB-6L

Shade of colour	Black
Capacity	675 mAh
Voltage	3.7 V
Model	Li-Ion

- Use with UL/IEC-certified branded cells: for increased safety
- Safety electronics: for monitoring of the charging and discharge process
- Gold-plated contacts: for fewer contact losses and prevention of corrosion
- Self-resetting thermal fuse (Polyswitch/PTC): additional protection against short circuits and overload

00077546	
6	HB



hama

"DP 321" Lithium Ion Battery for Nikon EN-EL3e

Capacity	1500 mAh
Voltage	7.4 V
Model	Li-Ion

- Use with UL/IEC-certified branded cells: for increased safety
- Safety electronics: for monitoring of the charging and discharge process
- Gold-plated contacts: for fewer contact losses and prevention of corrosion
- Self-resetting thermal fuse (Polyswitch/PTC): additional protection against short circuits and overload

00077525	
6	HB

Rechargeable Batteries & Powerpacks



hama

"DP 323" Lithium Ion Battery for Nikon EN-EL9

Capacity	900 mAh
Voltage	7.4 V
Model	Li-Ion

- Use with UL/IEC-certified branded cells: for increased safety
- Safety electronics: for monitoring of the charging and discharge process
- Self-resetting thermal fuse (Polyswitch/PTC): additional protection against short circuits and overload
- Fixation of the cells thanks to super-adhesive tape: for improved resistance to impacts and mechanical protection

00077523		
6	HB	



hama

"DP 482" Lithium Ion Battery for Nikon EN-EL14a

Shade of colour	Black
Capacity	800 mAh
Voltage	7.4 V
Model	Li-Ion

- Use with UL/IEC-certified branded cells: for increased safety
- Safety electronics: for monitoring of the charging and discharge process
- Gold-plated contacts: for fewer contact losses and prevention of corrosion
- Self-resetting thermal fuse (Polyswitch/PTC): additional protection against short circuits and overload

00077514		
6	HB	



hama

"DP 344" Li-Ion Battery for Olympus Li-50B

Capacity	800 mAh
Voltage	3.7 V
Model	Li-Ion

- Use with UL/IEC-certified branded cells: for increased safety
- Safety electronics: for monitoring of the charging and discharge process
- Gold-plated contacts: for fewer contact losses and prevention of corrosion
- Self-resetting thermal fuse (Polyswitch/PTC): additional protection against short circuits and overload

00077530		
6	HB	



hama

"DP 307" Lithium Ion Battery for Panasonic CGR-S006E

Capacity	700 mAh
Voltage	7.2 V
Model	Li-Ion

- Use with UL/IEC-certified branded cells: for increased safety
- Safety electronics: for monitoring of the charging and discharge process
- Gold-plated contacts: for fewer contact losses and prevention of corrosion
- Self-resetting thermal fuse (Polyswitch/PTC): additional protection against short circuits and overload

00077524		
6	HB	



hama

"DP 548" Lithium Ion Battery for Nikon EN-EL12

Shade of colour	Black
Capacity	970 mAh
Voltage	3.7 V
Model	Li-Ion

- Use with UL/IEC-certified branded cells: for increased safety
- Safety electronics: for monitoring of the charging and discharge process
- Gold-plated contacts: for fewer contact losses and prevention of corrosion
- Self-resetting thermal fuse (Polyswitch/PTC): additional protection against short circuits and overload

00077548		
6	HB	



hama

"DP 550" Li-Ion Battery for Olympus Li42B

Shade of colour	Black
Capacity	675 mAh
Voltage	3.7 V
Model	Li-Ion

- Use with UL/IEC-certified branded cells: for increased safety
- Safety electronics: for monitoring of the charging and discharge process
- Gold-plated contacts: for fewer contact losses and prevention of corrosion
- Self-resetting thermal fuse (Polyswitch/PTC): additional protection against short circuits and overload

00077550		
6	HB	



hama

"DP 317" Lithium Ion Battery for Panasonic CGA-S007E

Capacity	800 mAh
Voltage	3.7 V
Model	Li-Ion

- Use with branded cells: for increased safety
- Safety electronics: for monitoring of the charging and discharge process
- Gold-plated contacts: for fewer contact losses and prevention of corrosion
- Self-resetting thermal fuse (Polyswitch/PTC): additional protection against short circuits and overload

00077532		
6	HB	



hama

"DP 461" Lithium Ion Battery for Panasonic DMW-BLC12

Capacity	950 mAh
Voltage	7.2 V
Model	Li-Ion

- Use with UL/IEC-certified branded cells: for increased safety
- Safety electronics: for monitoring of the charging and discharge process
- Gold-plated contacts: for fewer contact losses and prevention of corrosion
- Self-resetting thermal fuse (Polyswitch/PTC): additional protection against short circuits and overload

00077540		
6	HB	

ENERGY



hama

"DP 541" Lithium Ion Battery for Panasonic DMW-BLG10

Shade of colour	Black
Capacity	700 mAh
Voltage	7.2 V
Model	Li-Ion

- Use with UL/IEC-certified branded cells: for increased safety
- Safety electronics: for monitoring of the charging and discharge process
- Gold-plated contacts: for fewer contact losses and prevention of corrosion

00077541		
6	HB	



hama

"DP 460" Lithium Ion Battery for Sony NP-BX1

Shade of colour	Black
Capacity	1090 mAh
Voltage	3.6 V
Model	Li-Ion

- Use with UL/IEC-certified branded cells: for increased safety
- Safety electronics: for monitoring of the charging and discharge process
- Gold-plated contacts: for fewer contact losses and prevention of corrosion

00077519		
6	HB	



hama

"DP 542" Lithium Ion Battery for Sony NP-FZ100

Shade of colour	Black
Capacity	1940 mAh
Voltage	7.2 V
Model	Li-Ion

- Use with UL/IEC-certified branded cells: for increased safety
- Safety electronics: for monitoring of the charging and discharge process
- Gold-plated contacts: for fewer contact losses and prevention of corrosion

00077542		
6	HB	



hama

Charger "Travel for Canon", Black

Connection	Micro USB coupling/ socket
------------	----------------------------

- LED function indicator gives information about the charge state
- Fast, simple and safe charging of the battery
- Perfect fit of the battery in the charger
- USB charging connection for USB mains adapters, USB car chargers, power packs
- Incl. USB connection cable (USB-A plug to micro-USB)
- Short-circuit-proof and reverse polarity protected (mechanical)

LP-E10	00081414
6	HB

ENERGY



hama

"DP 545" Lithium Ion Battery for Sony NP-BG1

Shade of colour	Black
Capacity	1020 mAh
Voltage	3.6 V
Model	Li-Ion

- Use with UL/IEC-certified branded cells: for increased safety
- Safety electronics: for monitoring of the charging and discharge process
- Gold-plated contacts: for fewer contact losses and prevention of corrosion

00077545		
6	HB	



hama

"DP 551" Lithium Ion Battery for Sony NP-FW50

Shade of colour	Black
Capacity	1000 mAh
Voltage	7.2 V
Model	Li-Ion

- Use with UL/IEC-certified branded cells: for increased safety
- Safety electronics: for monitoring of the charging and discharge process
- Gold-plated contacts: for fewer contact losses and prevention of corrosion

00077551		
6	HB	



hama

Charger "Travel for Canon", Black

Connection	Micro USB coupling/ socket
------------	----------------------------

- LED function indicator gives information about the charge state
- Fast, simple and safe charging of the battery
- Perfect fit of the battery in the charger
- USB charging connection for USB mains adapters, USB car chargers, power packs
- Incl. USB connection cable (USB-A plug to micro-USB)
- Short-circuit-proof and reverse polarity protected (mechanical)

LP-E6	00081415
6	HB

Charger & Power Supply Units



hama

Charger
"Travel for Canon", Black

Connection	Micro USB coupling/ socket
------------	-------------------------------

- LED function indicator gives information about the charge state
- Fast, simple and safe charging of the battery
- Perfect fit of the battery in the charger
- USB charging connection for USB mains adapters, USB car chargers, power packs
- Incl. USB connection cable (USB-A plug to micro-USB)
- Short-circuit-proof and reverse polarity protected (mechanical)

LP-E8	00081417
6	HB



hama

Charger
"Travel for Canon", Black

Connection	Micro USB coupling/ socket
------------	-------------------------------

- LED function indicator gives information about the charge state
- Fast, simple and safe charging of the battery
- Perfect fit of the battery in the charger
- USB charging connection for USB mains adapters, USB car chargers, power packs
- Incl. USB connection cable (USB-A plug to micro-USB)
- Short-circuit-proof and reverse polarity protected (mechanical)

NB-11L	00081422
6	HB



hama

Charger
"Travel for Canon", Black

Connection	Micro USB coupling/ socket
------------	-------------------------------

- LED function indicator gives information about the charge state
- Fast, simple and safe charging of the battery
- Perfect fit of the battery in the charger
- USB charging connection for USB mains adapters, USB car chargers, power packs
- Incl. USB connection cable (USB-A plug to micro-USB)
- Short-circuit-proof and reverse polarity protected (mechanical)

NB-12L/NB-13L	00081426
6	HB



hama

Charger
"Travel for Nikon", Black

Connection	Micro USB coupling/ socket
------------	-------------------------------

- LED function indicator gives information about the charge state
- Fast, simple and safe charging of the battery
- Perfect fit of the battery in the charger
- USB charging connection for USB mains adapters, USB car chargers, power packs
- Incl. USB connection cable (USB-A plug to micro-USB)
- Short-circuit-proof and reverse polarity protected (mechanical)

EN-EL14/EN-EL14a	00081412
6	HB



hama

Charger
"Travel for Canon", Black

Connection	Micro USB coupling/ socket
------------	-------------------------------

- LED function indicator gives information about the charge state
- Fast, simple and safe charging of the battery
- Perfect fit of the battery in the charger
- USB charging connection for USB mains adapters, USB car chargers, power packs
- Incl. USB connection cable (USB-A plug to micro-USB)
- Short-circuit-proof and reverse polarity protected (mechanical)

LP-E17	00081420
6	HB



hama

Charger
"Travel for Canon", Black

Connection	Micro USB coupling/ socket
------------	-------------------------------

- LED function indicator gives information about the charge state
- Fast, simple and safe charging of the battery
- Perfect fit of the battery in the charger
- USB charging connection for USB mains adapters, USB car chargers, power packs
- Incl. USB connection cable (USB-A plug to micro-USB)
- Short-circuit-proof and reverse polarity protected (mechanical)

LP-E12	00081424
6	HB



hama

Charger
"Travel for Canon", Black

Connection	Micro USB coupling/ socket
------------	-------------------------------

Battery Type	Lilon
--------------	-------

- LED function indicator gives information about the charge state
- Fast, simple and safe charging of the battery
- Perfect fit of the battery in the charger
- USB charging connection for USB mains adapters, USB car chargers, power packs
- Incl. USB connection cable (USB-A plug to micro-USB)

NB-6L	00081429
6	HB



hama

Charger
"Travel for Nikon", Black

Connection	Micro USB coupling/ socket
------------	-------------------------------

- LED function indicator gives information about the charge state
- Fast, simple and safe charging of the battery
- Perfect fit of the battery in the charger
- USB charging connection for USB mains adapters, USB car chargers, power packs
- Incl. USB connection cable (USB-A plug to micro-USB)
- Short-circuit-proof and reverse polarity protected (mechanical)

EN-EL15	00081419
6	HB

ENERGY

Charger & Power Supply Units

ENERGY



hama

Charger
"Travel for Nikon", Black

Connection	Micro USB coupling/ socket
------------	-------------------------------

- LED function indicator gives information about the charge state
- Fast, simple and safe charging of the battery
- Perfect fit of the battery in the charger
- USB charging connection for USB mains adapters, USB car chargers, power packs
- Incl. USB connection cable (USB-A plug to micro-USB)
- Short-circuit-proof and reverse polarity protected (mechanical)

EN-EL12	00081428
6	HB



hama

Charger
"Travel for Nikon", Black

Connection	Micro USB coupling/ socket
------------	-------------------------------

- LED function indicator gives information about the charge state
- Fast, simple and safe charging of the battery
- Perfect fit of the battery in the charger
- USB charging connection for USB mains adapters, USB car chargers, power packs
- Incl. USB connection cable (USB-A plug to micro-USB)
- Short-circuit-proof and reverse polarity protected (mechanical)

EN-EL5	00081432
6	HB



hama

Charger
"Travel for Panasonic", Black

Connection	Micro USB coupling/ socket
------------	-------------------------------

- LED function indicator gives information about the charge state
- Fast, simple and safe charging of the battery
- Perfect fit of the battery in the charger
- USB charging connection for USB mains adapters, USB car chargers, power packs

DMW-BLG10	00081416
6	HB
DMW-BLC12	00081418
6	HB



hama

Charger
"Travel for Sony", Black

Connection	Micro USB coupling/ socket
------------	-------------------------------

- LED function indicator gives information about the charge state
- Fast, simple and safe charging of the battery
- Perfect fit of the battery in the charger
- USB charging connection for USB mains adapters, USB car chargers, power packs
- Incl. USB connection cable (USB-A plug to micro-USB)
- Short-circuit-proof and reverse polarity protected (mechanical)

NP-FZ100	00081421
6	HB



hama

Charger
"Travel for Nikon", Black

Connection	Micro USB coupling/ socket
------------	-------------------------------

- LED function indicator gives information about the charge state
- Fast, simple and safe charging of the battery
- Perfect fit of the battery in the charger
- USB charging connection for USB mains adapters, USB car chargers, power packs
- Incl. USB connection cable (USB-A plug to micro-USB)
- Short-circuit-proof and reverse polarity protected (mechanical)

EN-EL9	00081431
6	HB



hama

Charger
"Travel for Olympus", Black

Connection	Micro USB coupling/ socket
------------	-------------------------------

- LED function indicator gives information about the charge state
- Fast, simple and safe charging of the battery
- Perfect fit of the battery in the charger
- USB charging connection for USB mains adapters, USB car chargers, power packs
- Incl. USB connection cable (USB-A plug to micro-USB)
- Short-circuit-proof and reverse polarity protected (mechanical)

LI-40B/LI-42B	00081430
6	HB



hama

Charger
"Travel for Sony", Black

Connection	Micro USB coupling/ socket
------------	-------------------------------

- LED function indicator gives information about the charge state
- Fast, simple and safe charging of the battery
- Perfect fit of the battery in the charger
- USB charging connection for USB mains adapters, USB car chargers, power packs
- Incl. USB connection cable (USB-A plug to micro-USB)
- Short-circuit-proof and reverse polarity protected (mechanical)

NP-BX1	00081413
6	HB



hama

Charger
"Travel for Sony", Black

Connection	Micro USB coupling/ socket
------------	-------------------------------

- LED function indicator gives information about the charge state
- Fast, simple and safe charging of the battery
- Perfect fit of the battery in the charger
- USB charging connection for USB mains adapters, USB car chargers, power packs
- Incl. USB connection cable (USB-A plug to micro-USB)
- Short-circuit-proof and reverse polarity protected (mechanical)

NP-BN1	00081423
6	HB



hama

Charger
"Travel for Sony", Black

Connection	Micro USB coupling/ socket
------------	-------------------------------

- LED function indicator gives information about the charge state
- Fast, simple and safe charging of the battery
- Perfect fit of the battery in the charger
- USB charging connection for USB mains adapters, USB car chargers, power packs
- Incl. USB connection cable (USB-A plug to micro-USB)
- Short-circuit-proof and reverse polarity protected (mechanical)

NP-BG1	00081425
	120 HB



hama

Charger
"Travel for Sony", Black

Connection	Micro USB coupling/ socket
------------	-------------------------------

- LED function indicator gives information about the charge state
- Fast, simple and safe charging of the battery
- Perfect fit of the battery in the charger
- USB charging connection for USB mains adapters, USB car chargers, power packs
- Incl. USB connection cable (USB-A plug to micro-USB)
- Short-circuit-proof and reverse polarity protected (mechanical)

NP-FW50	00081411
	6 HB

ENERGY

Accessories for Flashes



Flash accessories

Flash/Lighting Rail



hama

Flash Bracket, 90°, foldable, black

Material	Metal, Plastic Material
W x H x L	3.4 x 14 x 19 cm

- For all flash units, lights, synchro-mats and tilt heads with a standard accessory shoe
- For all photo/video cameras with a tripod socket
- Sliding A 1/4" (6.4 mm) camera screw and B 1/4" (6.4 mm) tripod socket
- Hand grip for ease of use
- With a hand strap for a secure hold
- Plastic surface
- Being foldable and compact, the bracket is ultra portable
- Larger illumination angle as the flash unit is attached next to the camera
- Prevents the effect of "red eye" as the flash comes from another angle and not directly from near the lens as this would be the case without a flash bracket
- Easy to use: the camera and flash unit are compactly attached to the flash bracket that ensures optimal weight shift for portrait shots

1/4" (6.4 mm)	00006831
6 BK	



hama

Flash Rail, 30 x 177 mm, black/grey

Material	Plastic Material
W x H x L	3 x 2.3 x 17.7 cm

- For all flash devices, lights, Synchro-mats and tilt heads with standard attachment base
- Suitable for photo / video cameras with tripod thread
- With a standard flash shoe and mobile camera screw A 1/4" (6.4 mm), tripod thread B 1/4" (6.4 mm)
- Plastic runner
- Wider lighting angle, because the flash device is attached next to the camera
- Prevents the "red-eye effect" because the flash is coming from a different angle, and not, as is the case without the flash rail, directly from the proximity of the lens
- Easy handling: the camera and flash device are compactly attached to the flash rail, and the flash rail ensures the ideal distribution of weight for portrait shots

1/4" (6.4 mm)	00006815
6 BK	

Flash Adapter/Tilt Head



hama

Plug-in Foot with Tripod Thread

Shade of colour	Silver
Contact	Isolated Center Contact

- Tripod threads (A 1/4"/6.4 mm) and 2 locking nuts
- Foot without threaded hole for attachment and secure fastening to the camera or rail's flash shoe

	00006958
6 BK	



hama

Accessory Shoe with Insulating Plate

Shade of colour	Black
Contact	Isolated Center Contact

- Isolating plate prevents the current flow from the camera to the photography accessories and vice versa
- With tripod socket B 1/4"

	00006959
6 BK	

Clean & Care



Cleaners & Care Products

Compressed Air Cleaner



hama

Compressed Air Cleaner "AntiDust"

- Ideal for cleaning hard-to-access parts of cameras and equipment
- Monoblock tin with screw head for increased blow intensity
- Gas pressure stable until the end of the filling process
- With spray valve and capillary tube

400 ml				00005801
	30	K.A.		
250 ml				00005800
	30	K.A.		

CLEAN & CARE

Dust-Ex Brush



hama

Air Blower "Dust Ex Brush 55"

Diameter Rubber Bellow	5.5 cm
Length	16 cm

- With a brush for removing heavy soiling and coarse particles
- Air blower removes dust, crumbs and other small particles without touching the surface
- Valve system for optimised blowing action
- Brush can be attached to the side when not in use
- Environment-friendly as cleaning requires no fluids or chemicals

Black				00005649
	24	HB		



hama

"Dust Ex" Air Blower

Diameter Rubber Bellow	5.5 cm
Length	16.6 cm

- Removes dust, crumbs and other small particles without touching the surface
- Valve system for optimised blowing action
- Environment-friendly as cleaning requires no fluids or chemicals
- Talc-free

Black				00005501
	24	HB		

Cleaning Kit



hama

"Optic Dry" Photo Cleaning Set, 4-part

- Set consisting of:
 - Dust Ex Brush:
 - With brush, for removing heavy soiling and coarser particles
 - Air blower removes dust, crumbs and other small particles without touching the surface
 - Valve system for optimised blowing action
 - Brush can be attached to the side when not in use
 - Environment-friendly
 - Talc-free

- Cleaning Cloth:
 - Removes dirt and dust from all optical surfaces
 - Especially high-quality microfibre cloth for lint-free cleaning

- Lenspen:
 - Highly efficient and gentle cleaning of all optical surfaces, especially for lenses and filters
 - Ready for use immediately, since the screw lock ensures automatic activation of the velvet surface and means that no special activation of the fibres is required
 - Especially long-lasting, since no liquid can dry out or leak with dry cleaning
 - Original Lenspen
 - Removes dust, specks of grease and other dirt
 - Does not dry out
 - With lens brush for dry pre-cleaning
 - Special coating for high-quality lenses
 - Handy pen shape with retaining clip in an ergonomic design

				00005954
	6	HB		



hama

"Optic HTMC Dust Ex" Photo Cleaning Set, 4-part

- With a brush for removing heavy soiling and coarse particles
- Made without silicone which avoids the formation of smears
- Set consisting of:

- Dust Ex Brush:
 - Air blower removes dust, crumbs and other small particles without touching the surface
 - Valve system for optimised blowing action
 - Brush can be attached to the side when not in use
 - Environment-friendly
 - Talc-free

- "HTMC-Special" Lens Cleaner, 12 ml:
 - For gentle, wet cleaning
 - Superior quality fluid for smear-free cleaning
 - Incl. application brush

- 30 Sheets of Fine Lens Paper:
 - Optimised for wet cleaning with special cleaning fluid

- Practical Mesh Storage Pouch, 12.5 x 17 cm

				00005946
	6	HB		



hama

"Optic HTMC" Photo Cleaning Set, 4-part

- With a brush for removing heavy soiling and coarse particles
- Made without silicone which avoids the formation of smears
- Set consisting of:

"Pneu 40" Lens Brush:

- Air blower removes dust, crumbs and other small particles without touching the surface
- Valve system for optimised blowing action
- With protective cap
- Environment-friendly
- Talc-free

"HTMC-Special" Lens Cleaner, 12 ml:

- For gentle, wet cleaning
- Superior quality fluid for smear-free cleaning
- Incl. application brush

30 Sheets of Fine Lens Paper:

- Optimised for wet cleaning with special cleaning fluid

Practical Mesh Storage Pouch, 13 x 18 cm

			00005947
60	HB		

Cleaning Pen



hama

"Glass Fibre" Contact Cleaner

- Length of glass fibre refill: 25 mm
- Length of pen: 120 mm

Black			00005629
	6	BK	

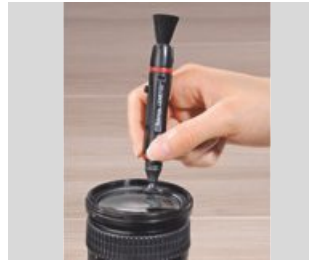

hama

"Classic" Lens Pen

Material Cleaning Spike	Special Velvet
Diameter Cleaning Spike	13 mm
Nib Length	11.5 cm

- Immediately ready for use as the screw closure ensures automatic activation of the velvety surface, no need to activate the fibers separately
- Particularly long service life as dry cleaning means that no liquid can dry out or run out
- Original lens pen
- Removes dust, grease spots and other smudges
- Does not dry out
- With a lens brush for dry precleaning
- Special coating for high-quality lenses
- Conveniently shaped pen with a clip for attachment and an ergonomic design
- Curved velvety surface
- Diameter: 13 mm, especially for lenses and filters

Black			00005961
	20	BK	



hama

Lens Pen

Material Cleaning Spike	Special Velvet
Diameter Cleaning Spike	13 mm
Nib Length	12.5 cm

- Particularly long service life as dry cleaning means that no liquid can dry out or run out
- Removes dust, grease spots and other smudges
- Does not dry out
- With a lens brush for dry precleaning
- Conveniently shaped pen with a clip for attachment
- Curved velvety surface
- Diameter: 13 mm, especially for lenses and filters

Black			00005604
	20	BK	

Cleaners & Care Products

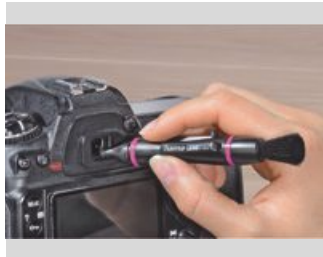

hama

"MicroPro II" Lens Pen

Material Cleaning Spike	Special Velvet
Diameter Cleaning Spike	5 mm
Nib Length	9 cm

- Particularly long service life as dry cleaning means that no liquid can dry out or run out
- Immediately ready for use as the screw closure ensures automatic activation of the velvety surface, no need to activate the fibers separately
- Original lens pen
- Removes dust, grease spots and other smudges
- Does not dry out
- With a lens brush for dry precleaning
- Special coating for high-quality lenses
- Small and handy pen with a clip for attachment and an ergonomic design
- Flat velvety surface
- Diameter: 5 mm, especially for eyepieces and smartphone cameras

Black	00005964
20 BK	

Cleaning Cloth



hama

Anti-static Cloth, 25 x 23 cm

Shade of colour	Orange
Material	100% Cotton
Width x Length	23 x 25 cm

- The antistatic effect prevents dust from accumulating again after the cleaning process
- Especially high-quality cleaning cloth made from 100% cotton for lint-free cleaning
- Excellent cleaning effect thanks to high-quality fibre structure

	00005999
8 HB	



hama

"Pro-Optik" Damp Cleaning Cloths, 24 Packs of 10 in Display

Shade of colour	Cream Nature
Material	Paper
Width x Length	12 x 14 cm

- The antistatic effect prevents dust from accumulating again after the cleaning process
- Wet cleaning perfect for stubborn dirt
- Ideal for travel

	00005970
24 SC	



hama

"Micro" Cleaning Cloth, 24 pieces/display box

Shade of colour	Light Grey
Material	80% Polyester
Width x Length	15.5 x 15.5 cm

- Microfibre cloth of superior quality for lint-free cleaning
- Cleans effectively thanks to its high-quality fibre structure
- Microfibre cleaning cloth (20% nylon, 80% polyester)

	00005904
24 SC	



hama

"Micro" Optical Cleaning Cloth, 14 Pcs in Display

Shade of colour	Light Grey
Material	80% Polyester
Width x Length	20 x 20 cm

- Microfibre cloth of superior quality for lint-free cleaning
- Ensures thorough and gentle cleaning

	00005989
14 SC	



hama

"Pocket" Microfibre Cleaning Cloth, black

Shade of colour	Black
Material	Microfibre
Width x Length	15 x 15 cm

- With clip for handy transport on the camera bag, carrying strap or keyring
- With neoprene protective pouch
- Excellent cleaning effect thanks to high-quality fibre structure
- Washable by hand, allowing it to be reused

	00005840
8 HB	



hama

Cleaning Set with 30 "Pro-Optik" Moist Wipes and 1 Microfibre Cloth

Shade of colour	Black
Material	Microfibre
Width x Length	12 x 14 cm

- The antistatic effect prevents dust from accumulating again after the cleaning process
- Microfibre cloth of superior quality for lint-free cleaning
- Moist disposable wipes for wet cleaning - ideal for stubborn dirt and perfect for when out and about

	00005988
6 HB	

CLEAN & CARE



hama

Optical Paper, 5 x 30 Pages

Shade of colour	Beige, Cream Nature
Width x Length	12 x 6 cm

- Made without silicone which avoids the formation of smears
- Optimised for wet cleaning with special cleaning fluid

			00005956
	6	HB	

Storage Media & Accessories

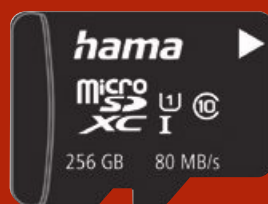

Bags & Cases

Sleeve



hama

Self-Adhesive Sleeves, pack of 5, white

Material	Plastic Material
Suitable for	SD & MMC

- High-quality, antistatic sleeves
- For attaching two SD cards each to a file, folder, photo album, etc.

00095950	
100	HC

Storage media bag



hama

Storage media bag "for Memory Cards"

Material	Polypropylene (PP)
Max. Capacity	8

- High-quality, antistatic sleeves
- Index can be labelled, allowing for organised archiving
- Holds up to 8 SD cards
- Coloured label on the back for easy sorting

Graphite	00095920
Blue	00095921
20	HC



hama

Memory Card Case, black

Material	Faux Leather
Max. Capacity	12

- High-quality, antistatic sleeves
- Index can be labelled, allowing for organised archiving
- With carrying strap

Black	00095980
120	SU



hama

"Vegas" Memory Card Case, size M, black

Material	Faux Leather
Max. Capacity	12

- Holds up to 8 SD and 4 microSD cards
- With specially developed safety insert
- Practical magnetic fastener

Black	00095964
120	HC



hama

Memory Card Case, black

Material	Faux Leather
Max. Capacity	18

- High-quality, antistatic sleeves
- Index can be labelled, allowing for organised archiving
- With carrying strap

Black	00095983
90	SU



hama

"Universal" Memory Card Case, small, black

Material	Faux Leather
Max. Capacity	4

- With hook and loop fastener

Black	00047152
200	HC



hama

"Universal" Memory Card Case, large, black

Material	Faux Leather
Max. Capacity	5

- With a compartment for a Compact-Flash adapter
- Loops for up to 4 AA batteries and one stylus pen

Black	00047153
60	SU



hama

"Mini" Memory Card Case, black/grey

Material	Polytex
Max. Capacity	10

- Holds up to 10 memory cards
- 2 insert pockets for small parts

Black	00049916		
	30	SU	

SD Memory Card

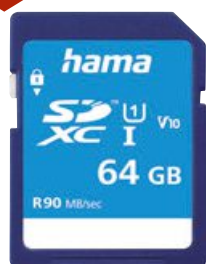

hama

SD Memory Card "Memory Fast", 90 MB/s

UHS Standard	UHS-I
Standard Speed Class	Class 10, UHS Speed Class 1
Video Speed Class	V10

- For real-time/broadcast recording; allows fast and direct data transfer between a memory card and a UHS-I capable terminal device
- SecureDigital Extended Capacity Card (SDXC), complies with SD 3.01 specifications
- Especially suited for real time full HD video and 3D video recording
- Mechanical write protection (against unintentional deleting)
- With a label area for short notes

256 GB	00123997		
	24	BK	
128 GB	00124137		
	24	BK	
64 GB	00124136		
	24	BK	

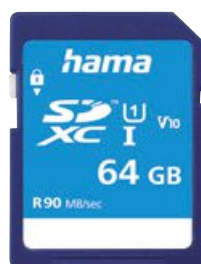

hama

SD Memory Card "Memory Fast, narrow packaging", 90 MB/s

UHS Standard	UHS-I
Standard Speed Class	Class 10
Video Speed Class	V10

- For real-time/broadcast recording; allows fast and direct data transfer between a memory card and a UHS-I capable terminal device
- SecureDigital-Extended-Capacity-Card (SDXC), compliant to the SD-3.01 standard
- Especially suitable for real time full HD video and 3D video recording
- Mechanical write protection (against accidental deletion)
- With labelling field for short notes

128 GB	00213111		
	32	BK	
64 GB	00213110		
	32	BK	



hama

SD Memory Card "Memory Fast", 80 MB/s

UHS Standard	UHS-I
Standard Speed Class	Class 10, UHS Speed Class 1
Video Speed Class	V10

- For real-time/broadcast recording; allows fast and direct data transfer between a memory card and a UHS-I capable terminal device
- SecureDigital High Capacity Card (SDHC), complies with SD 3.01 specifications
- Especially suited for real time full HD video and 3D video recording
- Mechanical write protection (against unintentional deleting)
- With a label area for short notes

32 GB	00124135		
	24	BK	
16 GB	00124134		
	24	BK	

Memory Cards

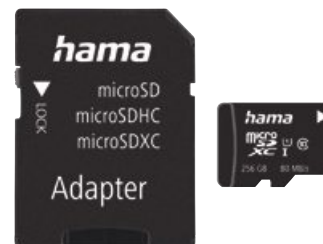
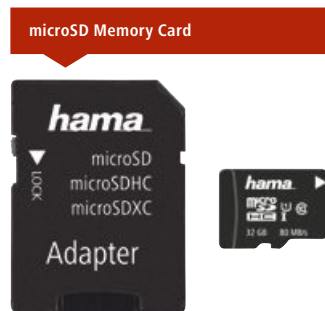
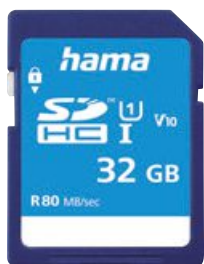

hama

**SD Memory Card
"Memory Fast, narrow
packaging", 80 MB/s**

UHS Standard	UHS-I
Standard Speed Class	Class 10, UHS Speed Class 1
Video Speed Class	V10

- For real-time/broadcast recording; allows fast and direct data transfer between a memory card and a UHS-I capable terminal device
- SecureDigital High Capacity Card (SDHC), meets new SD 3.01 standard
- Especially suitable for real time full HD video and 3D video recording
- Mechanical write protection against accidental deletion
- With labelling field for short notes

32 GB				00181095
		32	BK	
16 GB				00181094
		32	BK	

hama

**SD Memory Card
"Memory Base", 10 MB/s**

Standard Speed Class	Class 4
----------------------	---------

- SecureDigital Card
- Suitable for terminal devices with SecureDigital slot
- Mechanical write protection against unintentional deleting
- With a label area for short notes

2 GB				00055377
		24	BK	

hama

**microSD Memory Card
"Class 10 + Adapter/Mobile",
80 MB/s**

UHS Standard	UHS-I
Standard Speed Class	Class 10

- For real-time/broadcast recording; allows fast and direct data transfer between a memory card and a UHS-I capable terminal device
- micro SecureDigital High Capacity Card (microSDHC), meets the new SD 3.01 standard
- Especially suitable for real-time full HD video and 3D video recording
- Incl. adapter to SD card format

64 GB				00139506
		24	BK	
32 GB				00139505
		24	BK	

hama

**microSD Memory Card
"Memory Fast + Adapter/
Photo", 80 MB/s**

UHS Standard	UHS-I
Standard Speed Class	Class 10, UHS Speed Class 1
Video Speed Class	V10

- For real-time/broadcast recording; allows fast and direct data transfer between a memory card and a UHS-I capable terminal device
- micro SecureDigital Extended Capacity Card (microSDHC), complies with new SD 3.01 specifications
- Especially suited for real-time full HD video and 3D video recording
- Adapter for SD card format included

256 GB				00124173
		24	BK	
128 GB				00124160
		24	BK	
64 GB				00124152
		24	BK	
32 GB				00124151
		24	BK	
16 GB				00124150
		24	BK	



hama

microSD Memory Card „Memory Fast + Adapter / Photo, Narrow Pack.“, 80 MB/s

UHS Standard	UHS-I
Standard Speed Class	Class 10
Video Speed Class	V10

- For real-time/broadcast recording; allows fast and direct data transfer between a memory card and a UHS-I capable terminal device
- micro SecureDigital High Capacity Card (microSDHC), meets the new SD 3.01 standard
- Especially suitable for real-time full HD video and 3D video recording
- Incl. adapter to SD card format

32 GB	00213114
16 GB	00213113

hama

microSD Memory Card "Memory Fast + Adapter/Mobile", 80 MB/s

UHS Standard	UHS-I
Standard Speed Class	UHS Speed Class 1
Video Speed Class	V10

- For real-time/broadcast recording; allows fast and direct data transfer between a memory card and a UHS-I capable terminal device
- micro SecureDigital Extended Capacity Card (microSDXC), complies with new SD 3.01 specifications
- Especially suited for real-time full HD video and 3D video recording
- Adapter for SD card format included

128 GB	00124158
64 GB	00124140
32 GB	00124139
16 GB	00124138
256 GB	00124171

hama

microSDXC 256 GB Class 10 UHS-I 80MB/s + Adapter/Mobile

UHS Standard	UHS-I
Standard Speed Class	Class 10
Video Speed Class	V10

- For real-time/broadcast recording; allows fast and direct data transfer between a memory card and a UHS-I capable terminal device
- micro SecureDigital Extended Capacity Card (microSDXC), meets new SD 3.01 standard
- Especially suitable for real-time full HD video and 3D video recording
- Incl. adapter to SD card format

256 GB	00213117
--------	----------

hama

microSD Memory Card "Memory Pro 4K + Adapter/Photo", 80 MB/s

UHS Standard	UHS-I
Standard Speed Class	UHS Speed Class 3
Video Speed Class	V30

- Allows perfect, high-resolution 4k video recordings with a guaranteed minimum write speed of 30 MB/sec.
- micro SecureDigital Extended Capacity Card (microSDXC), complies with new SD 3.01 specifications
- Especially suited for 4k cinema video, real time full HD video and 3D video recordings
- Comes with an adapter for SD card format

128 GB	00181002
64 GB	00123982

Memory Cards | Cardreader



hama

microSD Memory Card „Memory Pro 4K + adapter / photo, narrow pack.“, 80 MB/s

UHS Standard	UHS-3
Standard Speed Class	UHS Speed Class 3
Video Speed Class	V30

- Allows perfect, high-resolution 4k video recordings with a guaranteed minimum write speed of 30 MB/sec.
- micro SecureDigital Extended Capacity Card (microSDXC), meets new SD 3.01 standard
- Especially suitable for 4K cinema video, real-time full-HD video and 3D video recording
- Incl. adapter to SD card format

hama

microSD Memory Card "Memory Pro 4K + Adapter/ Mobile", 80 MB/s

UHS Standard	UHS-I
Standard Speed Class	UHS Speed Class 3
Video Speed Class	V30

- Allows perfect, high-resolution 4k video recordings with a guaranteed minimum write speed of 30 MB/sec.
- micro SecureDigital Extended Capacity Card (microSDXC), complies with new SD 3.01 specifications
- Especially suited for 4k cinema video, real time full HD video and 3D video recordings
- Comes with an adapter for SD card format

128 GB				00213116
	32	BK		
64 GB				00213115
	32	BK		

128 GB				00181000
	24	BK		
64 GB				00123979
	24	BK		

Card Reader



hama

Card Reader "SD/microSD, Aluminium"

Connection	USB-Typ-A-Plug
Data Transfer Rate	Up to 5 Gbit/s
USB Standard	USB 3.0

- Allows fast data transfer between the card and the PC when used with a UHS-I capable SD/microSD card
- Allows direct data exchange between memory cards
- High-quality and robust metal casing
- LED function indicator gives information about the connection status
- Supports USB 3.0 SuperSpeed 5 Gbps
- Downward compatible with USB 2.0 (480 Mbit/s) and USB 1.1 (12 Mbit/s)

Memory cards:
 • SD/SDHC/SDXC
 • microSD/microSDHC/microSDXC
 • Operating system: Windows 11/10/8/7/Vista/XP or Mac OS 9.x or higher

Black				00123900
	30	BK		



hama

Card Reader "SD/microSD/CF/MS"

Connection	USB-Typ-A-Plug
Data Transfer Rate	Up to 5 Gbit/s
USB Standard	USB 3.0

- Allows fast data transfer between the card and the PC when used with a UHS-I capable SD/microSD card
- Allows fast data transfer between the card and the PC when used with a UDMA capable CF card
- Allows direct data exchange between memory cards
- Super speed data transfer rates of up to 5 Gbps
- LED function indicator gives information about the connection status
- Backwards-compatible with USB 2.0 (480 Mbit/s)
- Supports UDMA 7 mode
- Unique PID and VID

Memory Cards:
 • SD/SDHC/SDXC
 • MicroSD/microSDHC/microSDXC
 • CompactFlash I
 • MS/MS Duo/MS PRO Duo/MS PRO Duo HG
 • Operating system: Windows 11/10/8/7/Vista/XP or Mac OS 9.x or later

White				00181017
Black				00181018
	25	BK		



hama

USB 3.0 Multi-Card Reader, SD/microSD/CF, black

Connection	USB-Typ-A-Plug
Data Transfer Rate	Up to 5 Gbit/s
USB Standard	USB 3.0

- Allows fast data transfer between the card and the PC when used with a UDMA capable CF card
- Allows fast data transfer between the card and the PC when used with a UHS-I capable SD/microSD card
- USB cable for connection to a PC / laptop
- Supports USB 3.0 SuperSpeed 5 Gbps
- Backwards-compatible with USB 2.0 (480 Mbit/s) and USB 1.1 (12 Mbit/s)

Memory Cards:

- SD/SDHC/SDXC
- MicroSD/microSDHC/microSDXC
- CompactFlash I
- Operating system: Windows 11/10/8/7/Vista/XP and Mac OS 9.x or later

Black	00124022
25	SC



hama

USB 3.0 Card Reader, SD/micro SD, anthracite

Connection	USB-Typ-A-Plug
Data Transfer Rate	Up to 5 Gbit/s
USB Standard	USB 3.0

- LED function indicator provides information about the connection status
- Supports USB 3.0 (5 Gbit/s), USB 2.0 (480 Mbit/s) and USB 1.1 (12 Mbit/s)
- 2-slot solution with direct USB connection (no USB cable required)
- Ideal for mobile use

Memory Cards:

- SD/SDHC/SDXC
- MicroSD/microSDHC/microSDXC
- Operating system: Windows 10/8/7/XP and MAC OS 9.x or later

Anthracite	00124194
25	SC



hama

"35in1" USB 2.0 Multi Card Reader, blue

Connection	USB-Typ-A-Plug
Data Transfer Rate	Up to 480 Mbit/s
USB Standard	USB 2.0

- Allows fast data transfer between the card and the PC when used with a UDMA capable CF card
- Allows direct data exchange between memory cards
- LED function indicator gives information about the connection status
- USB cable for connection with PC / laptop
- Supports USB 2.0 (480 Mbit/s) and USB 1.1

Memory cards:

- SD/SDHC/SDXC
- microSD/microSDHC/microSDXC (with adapter, not included in the delivery package)
- CompactFlash I & II
- MS/MS Duo/MS PRO Duo/MS PRO Duo HG
- Smart Media Card
- xD-Picture Card
- Operating system: Windows 11/10/8/7/Vista/XP and Mac OS 9.x or higher

Blue	00055348
25	SC



hama

USB 2.0 Multi Card Reader, SD/microSD/CF, blue

Connection	USB-Typ-A-Plug
Data Transfer Rate	Up to 480 Mbit/s
USB Standard	USB 2.0

- Allows fast data transfer between the card and the PC when used with a UDMA capable CF card
- LED function indicator gives information about the connection status
- USB cable for connection with PC / laptop
- Supports USB 2.0 (480 Mbit/s)

Memory cards:

- SD/SDHC/SDXC
- microSD/microSDHC/microSDXC
- CompactFlash I
- Operating system: Windows 11/10/8/7/Vista/XP and Mac OS 9.x or higher

Blue	00124131
25	PO

Cardreader | Memory card storage



hama

"8in1" USB 2.0 Card Reader, SD/microSD, transparent

Connection	USB-Typ-A-Plug
Data Transfer Rate	Up to 480 Mbit/s
USB Standard	USB 2.0

- Allows direct data exchange between memory cards
- LED function indicator gives information about the connection status
- Supports USB 2.0 (480 Mbit/s) and USB 1.1 (12 Mbit/s)
- 2 slot solution with direct USB connection (no USB cable necessary)
- Ideal for travelling

Memory cards:
 • SD/SDHC/SDXC
 • microSD/microSDHC/microSDXC
 • Operating system: Windows 11/10/8/7/Vista/XP bzw. Mac OS 9.x or higher

Transparent	00091092
	50 BK

Memory Card Box



hama

Memory Card Box, black/transparent

Material	Plastic Material
Max. Capacity (Pieces)	10

- Holds up to 10 memory cards
- Flexible, breakproof box which protects the cards from becoming damaged
- Date and memo area (can be labelled)
- Extremely flat and space-saving
- Fits in a 10x15 slip-in photo album

Black	00095985
	180 BK



hama

"DuoCase" Memory Card Box, transparent

Material	Plastic Material
Max. Capacity (Pieces)	2
Suitable for	SD & MMC

- Prevents your memory card from becoming damaged
- Flexible, breakproof box
- Extremely flat and space-saving

Transparent	00095947
	6 BK



hama

"SD Slim Box" Memory Card Box, transparent

Material	Plastic Material
Max. Capacity (Pieces)	1
Suitable for	SD & MMC

- Prevents your memory card from becoming damaged
- Flexible, breakproof box
- Extremely flat and space-saving

Transparent	00095949
	6 BK



hama

"DuoCase" Memory Card Box, for 2 Cards, transparent

Material	Polypropylene (PP)
Max. Capacity (Pieces)	2
Suitable for	SD & MMC

- Protects the memory card from damage
- Flexible, shatterproof protective box, ideal for transport in a laptop bag, etc.
- Extremely flat and space-saving

Transparent	00095988
	8 HB



hama

"SD Slim Box" Memory Card Box, for 1 Card, transparent

Material	Polypropylene (PP)
Max. Capacity (Pieces)	1
Suitable for	SD & MMC

- Protects the memory card from damage
- Flexible, shatterproof protective box, ideal for transport in a laptop bag, etc.
- Extremely flat and space-saving

Transparent	00095989
	8 HB

External SSD Hard Drive

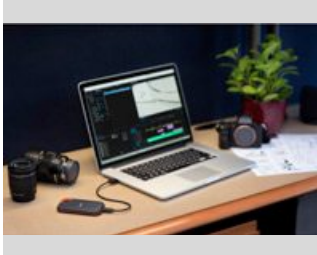

SanDisk

External SSD Hard Drive "Extreme Pro Portable, USB 3.2 Gen 2x2", Black, Orange

Transfer Rate (Reading)	2000 MB/s
Transfer Rate (Writing)	2000 MB/s

- USB 3.2 Gen 2x2 interface for extreme fast transfer speeds
- Read- and write speeds of up to 2000 MB/s
- Lightweight and pocket-sized for more portability
- IP55 rating for dust and water resistance
- Forged aluminum structure with durable silicone coating
- Works with Windows and Mac Computers and USB-C and USB-A inputs
- Password protection and 256-bit AES file encryption software

2 TB	00186535
	5 HB

Label



hama

Memory Card Labels, 18 pieces, black/white

Suitable for	SD & MMC
--------------	----------

- Self-adhesive

			00095916
	100	HC	

Slide



Storage Systems | Mounting of slides & Projection

Storage Sleeve



hama

Slide Sleeves for 20 Framed Slides in 5x5 cm Format, 25 pcs.

Shade of colour	Transparent
Format	Vertical Format
Material	Polypropylene (PP)
Model	Slide Cover
Number of Slides per Sleeve	20

- Safe storage: to protect your valuable slides from external influences such as dust and light and moisture
- Individual storage: Compile slides according to image sequence or theme, for example

			00002004
	12	PO	

Slide Viewer



hama

"LED" Slide Viewer, 3 x Magnification

Shade of colour	Black
Max. Magnification Factor	3
Slide Format	5 x 5 cm
Power Supply	Battery

- For all slide frames 5 x 5 cm in size
- With LED lighting, for 2 Mignon AA batteries, 1.5 V

			00001655
	6	HB	

SLIDE



hama

Slide Sleeves for 20 Framed Slides in 5x5 cm Format, 12 pcs.

Shade of colour	Transparent
Format	Vertical Format
Material	Polypropylene (PP)
Model	Slide Cover
Number of Slides per Sleeve	20

- Safe storage: to protect your valuable slides from external influences such as dust and light and moisture
- Individual storage: Compile slides according to image sequence or theme, for example

			00002014
	12	PO	

Cinefilm & Video



Projectors | Adhesive Material

Telescreen

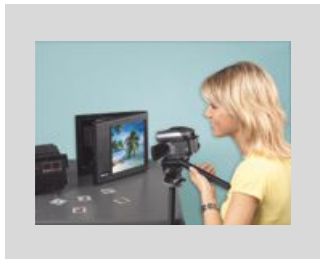

hama

Telescreen "Videotransfer"

Height of Screen	20 cm
Width of Screen	20 cm

- Surface-reflective deflecting mirror for true-to-side images
- Also for viewing slides without darkening a room: slide image is displayed on the screen
- Easy to use: open the mirror up at an angle of 45° to the screen and direct the projector towards the mirror. The image is projected on the screen via the mirror and can easily be filmed.
- Can compactly be folded up

Black				00003012
	7	SC		

Video Cassette Adapter



hama

VHS-C/VHS "Auto" Cassette Adapter

Type Tape (invoer)	VHS-C
Uitvoer	VHS

- Suitable for VHS-C/S-VHS-C
- Includes a motor for automatically tautening the video tape
- Battery operated via 1x Mignon AA 1.5 V (not included)

				00044704
	6	HB		

Adhesive Foil



hama

Cinekett S 8 Splicing Tape, 1 Soundtrack Free

- Pastes over 4 images
- With cut-out for 1 soundtrack

				00003755
	30	HB		

Projection

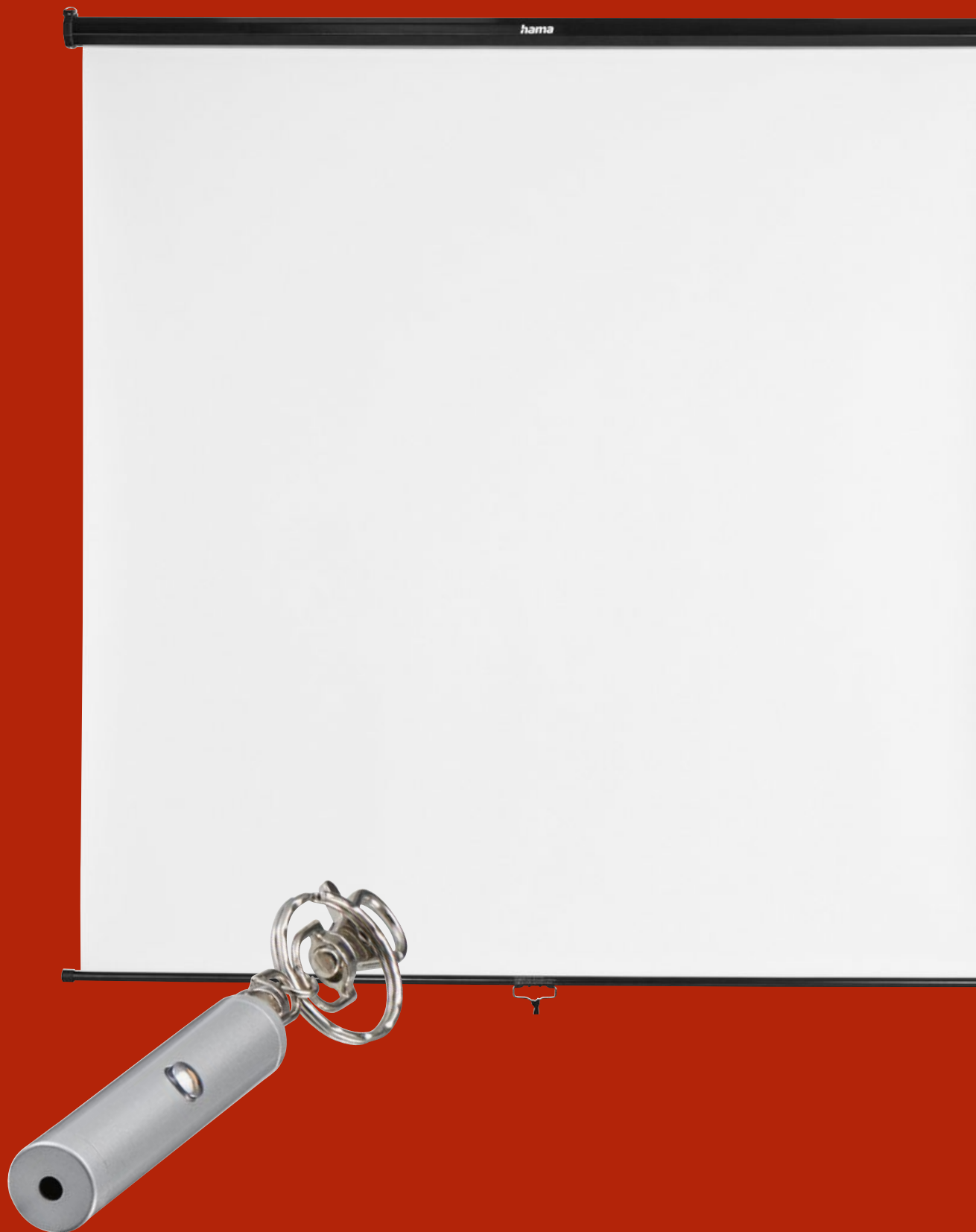

Projektor bag



hama

"Sportsline" Projector Bag, L, black

Shade of colour	Black
Material	Polytex

- Adjustable and removable inner divider to divide the bag as required
- Fully padded projector bag with variable inner divider
- Two large, variable-position additional pads with hook and loop fastening
- Projector retaining strap
- Integrated metal edging for stability
- Removable cable bag

00101066		
3	HT	

Projection Screen

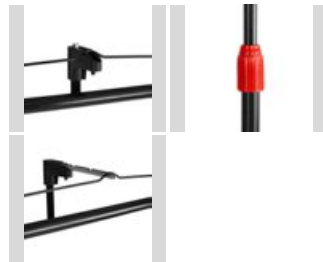

hama

Screen with tripod, 125 x 125 cm, 2-in-1, mobile set, telescopic tube, white

Gain-Value	1.1
Material Tube Body	Metal
Cloth Thickness	380 µm
Format	1:1 Standard
Projection Area	125 x 125 cm
Projection Diagonal	177 cm
Weight	6 kg

- The tripod projection screen with quick-release clip can be removed from the tripod and hung up on its own
- The spring mechanism allows the screen to be easily extended to the required size and secured in place, remaining crease-free in the process
- Steplessly adjustable telescopic tube
- white PVC screen for unique colour brilliance and the finest contrast richness for rooms to be darkened
- transportable tripod screen sized 125 cm x 125 cm - Format 1:1
- black metal tube with a diameter of approx. 5.5 cm
- quick setup and disassembly of the screen and stand in a few seconds
- Usefully shaped plastic handle with locking lever
- Stable tripod with non-slip plastic foot caps
- Can be stowed and transported in a space-saving manner
- black, opaque back side

PVC	00021575
1	SC



hama

Screen with tripod, 155 x 155 cm, 2-in-1, mobile set, telescopic tube, white

Gain-Value	1.1
Material Tube Body	Metal
Cloth Thickness	380 µm
Format	1:1 Standard
Projection Area	155 x 155 cm
Projection Diagonal	219 cm
Weight	7.5 kg

- The tripod projection screen with quick-release clip can be removed from the tripod and hung up on its own
- The spring mechanism allows the screen to be easily extended to the required size and secured in place, remaining crease-free in the process
- Steplessly adjustable telescopic tube
- white PVC screen for unique colour brilliance and the finest contrast richness for rooms to be darkened
- transportable tripod screen sized 155 cm x 155 cm - Format 1:1
- black metal tube with a diameter of approx. 5.5 cm
- quick setup and disassembly of the screen and stand in a few seconds
- Usefully shaped plastic handle with locking lever
- Stable tripod with non-slip plastic foot caps
- Can be stowed and transported in a space-saving manner
- black, opaque back side

PVC	00021574
1	SC



hama

Roll-up screen, 175 x 175 cm, mobile, for ceiling or wall mounting, white

Gain-Value	1.1
Material Tube Body	Metal
Cloth Thickness	380 µm
Format	1:1 Standard
Projection Area	175 x 175 cm
Projection Diagonal	247 cm
Weight	7 kg

- Enjoy the best views: The pull-out screen has a steplessly adjustable blocking system so you can set the image in the perfect screen format – for a real home cinema feel
- lightweight projection screen for quick and easy wall and ceiling mounting
- white PVC screen for unique colour brilliance and the finest contrast richness for rooms to be darkened
- transportable projection screen sized 175 cm x 175 cm
- black metal tube with a diameter of approx. 7 cm
- secure height adjustment via variably adjustable blocking system
- Can be stowed and transported in a space-saving manner
- black, opaque back side
- aspect ratio 1:1

PVC	00021576
1	SC



hama

Screen with tripod, 180 x 180 cm, 2-in-1, mobile set, telescopic tube, white

Gain-Value	1.1
Material Tube Body	Metal
Cloth Thickness	380 µm
Format	1:1 Standard
Projection Area	180 x 180 cm
Projection Diagonal	255 cm
Weight	9 kg

- The tripod projection screen with quick-release clip can be removed from the tripod and hung up on its own
- The spring mechanism allows the screen to be easily extended to the required size and secured in place, remaining crease-free in the process
- Steplessly adjustable telescopic tube
- white PVC screen for unique colour brilliance and the finest contrast richness for rooms to be darkened
- transportable tripod screen sized 180 cm x 180 cm - Format 1:1
- black metal tube with a diameter of approx. 5.5 cm
- quick setup and disassembly of the screen and stand in a few seconds
- Usefully shaped plastic handle with locking lever
- Stable tripod with non-slip plastic foot caps
- Can be stowed and transported in a space-saving manner
- black, opaque back side

PVC				00021573
		1	SC	

Projector Table



hama

Projector Table with 2 Levels (42 x 50 / 40 x 35 cm), Height-Adjustable, wi

Maximum Load	10 kg
Width x Depth x Height	110 cm

- Dynamic presentations: with two highly flexible platforms that can be adjusted in terms of height, inclination and orientation, you can direct your projector presentation perfectly for your audience
- Flexible use of the two platforms: for projectors and the lower level as a working surface, e.g. for a notebook and documents

Black				00077510
		1	SC	

Laser Pointer



hama

"LP-1R" Laser Pointer, red

Colour Laser	Red
Colour of the Housing	Chrome (matte)
Max. Range	50 m
Diameter	12 mm
Length	67 mm

- The red laser is ideal for emphasizing important points in darkened surroundings
- Metal housing in a timeless design
- Incl. key ring and snap hook for attachment to bags or key collections
- Laser class 2 less than 1 mW

				00003500
		24	HB	



hama

"LP-LC1" laser pointer, red

Colour Laser	Red
Colour of the Housing	Silver
Max. Range	50 m
Diameter	13 mm
Length	69 mm

- The red laser is ideal for emphasizing important points in darkened surroundings
- Metal housing in a timeless design
- Incl. key ring and snap hook for attachment to bags or key collections

				00003502
		144	HB	

Storage Systeme



Storage Systems

File



hama

File
"4-ring combination mechanism, 39 mm spine width"

Binding	Art Print (Laminated)
Mechanics	4-Ring combination mechanism
Format	29 x 32.5 cm
Maximum Sheet Size	260 x 310 mm
Spine Width	39 mm

- Stable and lots of space: handy storage option for photographs, negatives or slides
- Safe storage: for protection against external influences such as dust, light or moisture

Yellow	00007549
	34 PO



hama

File
"4-ring combination mechanism, 39 mm spine width"

Binding	Art Print (Laminated)
Mechanics	4-Ring combination mechanism
Format	29 x 32.5 cm
Maximum Sheet Size	260 x 310 mm
Spine Width	39 mm

- Stable and lots of space: handy storage option for photographs, negatives or slides
- Safe storage: for protection against external influences such as dust, light and moisture

Blue	00007551
	34 PO



hama

"Negatives" Folder with 4-Ring Combi Mechanism, 39 mm Spine Width, black

Binding	Art Print (Laminated)
Mechanics	4-Ring combination mechanism
Format	29 x 32.5 cm
Maximum Sheet Size	260 x 310 mm
Spine Width	39 mm

- Stable and lots of space: handy storage option for photographs, negatives or slides
- Safe storage: for protection against external influences such as dust, light and moisture

Black	00007548
	34 PO

Storage Sleeve



hama

Slide Sleeves for 20 Framed Slides in 5x5 cm Format, 25 pcs.

Shade of colour	Transparent
Format	Vertical Format
Material	Polypropylene (PP)
Model	Slide Cover
Number of Slides per Sleeve	20

- Safe storage: to protect your valuable slides from external influences such as dust and light and moisture
- Individual storage: Compile slides according to image sequence or theme, for example

	00002004
	12 PO



hama

File
"4-ring combination mechanism, 39 mm spine width"

Binding	Art Print (Laminated)
Mechanics	4-Ring combination mechanism
Format	29 x 32.5 cm
Maximum Sheet Size	260 x 310 mm
Spine Width	39 mm

- Stable and lots of space: handy storage option for photographs, negatives or slides
- Safe storage: for protection against external influences such as dust, light and moisture

Pink	00007552
	34 PO



hama

File
"4-ring combination mechanism, 39 mm spine width"

Binding	Art Print (Laminated)
Mechanics	4-Ring combination mechanism
Format	29 x 32.5 cm
Maximum Sheet Size	260 x 310 mm
Spine Width	39 mm

- Stable and lots of space: handy storage option for photographs, negatives or slides
- Safe storage: for protection against external influences such as dust, light and moisture

Green	00007550
	34 PO



hama

File
"4-D ring mechanism, 70 mm spine width, with slipcase"

Binding	Art Print (Laminated)
Mechanics	4-Ring combination mechanism
Format	33,5 x 31 cm
Maximum Sheet Size	265 x 315 mm
Spine Width	77 mm

- FSC Mix: Paper from responsible sources

Black, Grey	00007546
White	00007547
	7 PO



hama

Slide Sleeves for 20 Framed Slides in 5x5 cm Format, 12 pcs.

Shade of colour	Transparent
Format	Vertical Format
Material	Polypropylene (PP)
Model	Slide Cover
Number of Slides per Sleeve	20

- Safe storage: to protect your valuable slides from external influences such as dust and light and moisture
- Individual storage: Compile slides according to image sequence or theme, for example

	00002014
	12 PO

STORAGE SYSTEMS



hama

Photo Sleeves, DIN A4, 4-8 Photos with a Size of 10x15 cm, clear, 10 Pcs.

Shade of colour	Transparent
Format	Vertical Format
Material	Polypropylene (PP)
Model	Photo Sleeve
Number of Photos per Sleeve	8
Picture Size	10 x 15 cm

- Safe storage: for protection of photos against external influences such as dust, light and moisture

00009777		
18	HC	



hama

Negative Sleeves, Glassine, 7 Strips of 6 Negatives, 24x36 mm, 100 pcs.

Shade of colour	Transparent
Material	Glassine Matt (PER)
Model	Negative Sleeve
Number of Negatives per Sleeve	42

- Safe storage: to protect your valuable negatives from external influences such as dust, light and moisture
- Individual storage: compile negatives according to themes, for example
- Tidy storage: one strip per pocket, filled from the side

00002251		
14	SC	

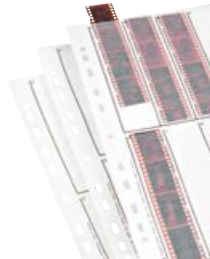

hama

Negative Sleeves, Glassine, 10 Strips of 4 Negatives, 24x36 mm, 25 pcs.

Shade of colour	Transparent
Material	Glassine Matt (PER)
Model	Negative Sleeve
Number of Negatives per Sleeve	40

- Safe storage: to protect your valuable negatives from external influences such as dust, light and moisture
- Individual storage: compile negatives according to themes, for example
- Tidy storage: one strip per pocket, filled from the side

00002252		
10	PO	

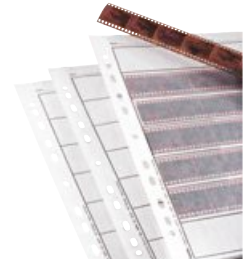

hama

Negative Sleeves, Glassine, 7 Strips of 6 Negatives, 24x36 mm, 25 pcs.

Shade of colour	Transparent
Material	Glassine Matt (PER)
Model	Negative Sleeve
Number of Negatives per Sleeve	42

- Safe storage: to protect your valuable negatives from external influences such as dust, light and moisture
- Individual storage: compile negatives according to themes, for example
- Tidy storage: one strip per pocket, filled from the side

00002250		
15	PO	



hama

Photo Sleeves, DIN A4, for 8 Photos with a Size of 10x15 cm, white, 10 Pcs.

Shade of colour	White
Format	Vertical Format
Material	Polypropylene (PP)
Model	Photo Sleeve
Number of Photos per Sleeve	8
Picture Size	10 x 15 cm

- Safe storage: for protection of photos against external influences such as dust, light and moisture

00009787		
12	HC	

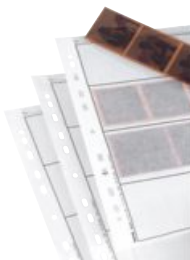

hama

Negative Sleeves, Glassine, 4 Strips of 3 Negatives, 6x7 cm, 100 pcs.

Shade of colour	Transparent
Material	Glassine Matt (PER)
Model	Negative Sleeve
Number of Negatives per Sleeve	12

- Safe storage: to protect your valuable negatives from external influences such as dust, light and moisture
- Individual storage: compile negatives according to themes, for example
- Tidy storage: one strip per pocket, filled from the side

00002259		
14	SC	

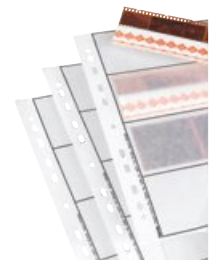

hama

Negative Sleeves, Glassine, 4 Strips of 3 Negatives, 6x6 cm, 25 pcs.

Shade of colour	Transparent
Material	Glassine Matt (PER)
Model	Negative Sleeve
Number of Negatives per Sleeve	12

- Safe storage: to protect your valuable negatives from external influences such as dust, light and moisture
- Individual storage: compile negatives according to themes, for example
- Tidy storage: one strip per pocket, filled from the side

00002256		
15	PO	

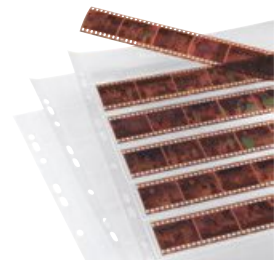

hama

Negative Sleeves, PP, 7 Strips of 6 Negatives, 24x36 cm, 100 pcs.

Shade of colour	Transparent
Material	Polypropylene (PP)
Model	Negative Sleeve
Number of Negatives per Sleeve	42

- Safe storage: to protect your valuable negatives from external influences such as dust, light and moisture
- Individual storage: compile negatives according to themes, for example
- Tidy storage: one strip per pocket, filled from the side

00002051		
8	SC	



hama

Negative Sleeves, PP, 1 Sheet for 40 Individual Negatives, 24x36 mm, 25 pcs.

Shade of colour	Transparent
Material	Polypropylene (PP)
Model	Negative Sleeve
Number of Negatives per Sleeve	40

- Safe storage: to protect your valuable negatives from external influences such as dust, light and moisture
- Individual storage: compile negatives according to image sequence or theme, for example, such as for self-cut negatives

			00002032
	12	PO	

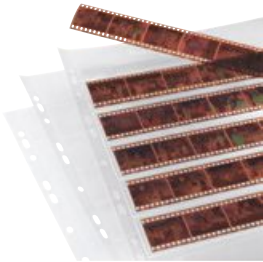

hama

Negative Sleeves, PP, 7 Strips of 6 Negatives, 24x36 mm, 25 pcs.

Shade of colour	Transparent
Material	Polypropylene (PP)
Model	Negative Sleeve
Number of Negatives per Sleeve	42

- Safe storage: to protect your valuable negatives from external influences such as dust, light and moisture
- Individual storage: compile negatives according to themes, for example
- Tidy storage: one strip per pocket, filled from the side

			00002050
	10	PO	

Album Sheets



hama

Album Sheets "23.3x31 cm, punched, 25 sheets"

Size	233 x 310 mm
------	--------------

- FSC Mix: Paper from responsible sources
- Photo cardboard can be used on both sides
- Ideal for sticking things in, ideal for classic photo archiving
- Lots of space for pictures and flat souvenirs (tickets, maps, coins, etc.) of various sizes
- Handy Euro punch holes: filing margin punched 4 x
- For personalised arrangement and creative design of the pages

White	00007555
Black	00007553
	48 PO



hama

Album Sheets "with glassine, 23.3x31 cm, punched, 25 sheets"

Size	233 x 310 mm
------	--------------

- FSC Mix: Paper from responsible sources
- Photo cardboard can be used on both sides
- Ideal for sticking things in, ideal for classic photo archiving
- Lots of space for pictures and flat souvenirs (tickets, maps, coins, etc.) of various sizes
- Handy Euro punch holes: filing margin punched 4 x
- For personalised arrangement and creative design of the pages
- With separating pages: the intermediate parchment pages offer ideal protection for your favourite pictures

White	00007556
Black	00007554
	36 PO

Cutting Machines

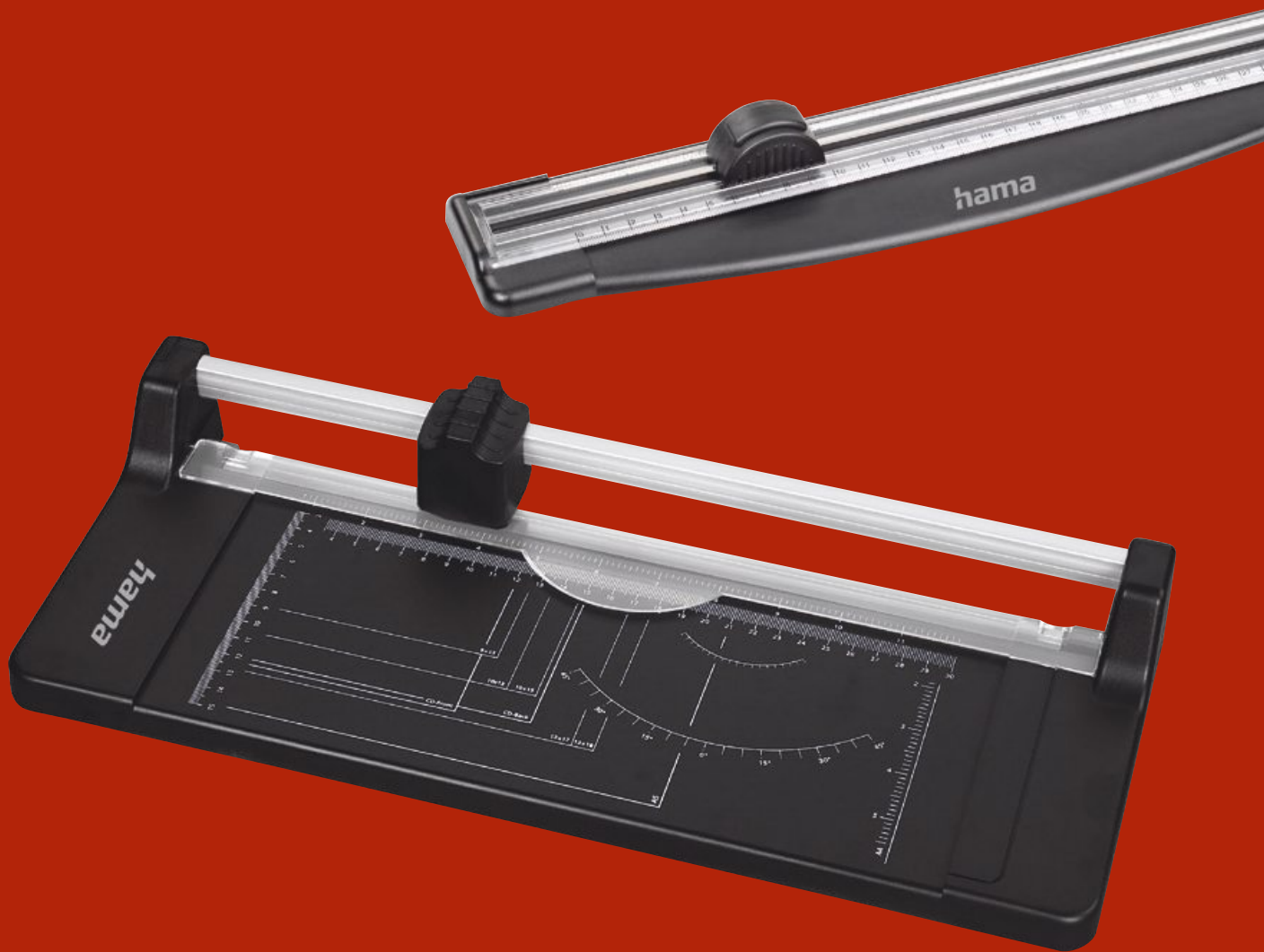

Office Equipment

Cutting Machine/accessories



hama

"Easy Cut R 320" Rotary Trimmer

Cut Height	0.5 mm
Cut Length	320 mm
Sheet Format	DIN A4, DIN A5, DIN A6

- Circular blade made of hardened steel
- Transparent clamping ruler
- Guide bar made of aluminium
- Scale for analogue and digital foto/DIN formats and CD/DVD covers
- Angle lines for angular cutting in 5° steps
- Cutting height: max. 5 sheets 80 g/m² (0.5 mm)

00008206

5 SC



hama

Lever Cutter
"ProCut S 330 Plus"

Cut Height	1 mm
Cut Length	330 mm
Sheet Format	DIN A4, DIN A5, DIN A6

- Lever cutter for paper and foil
- Clamping ruler with protective finger edge for optimal hold of the piece which is to be cut
- Marks on cutting table for analogue and digital picture/DIN formats with scale in CM and inch
- Formats and CD/DVD cover
- Angle lines for angular cutting in 5° steps
- Cutting height: max. 10 sheets 80 g/m² (1.0 mm)

00008212

5 SC



hama

"ProCut 310" Paper Trimmer

Cut Height	0.5 mm
Cut Length	310 mm

- Easy cutting ruler with cutting plate for mobile use
- Safe and straight cut, up to 31 cm, thanks to non-slip rubber feet
- Transparent clamping ruler with measurement division in cm & inch
- High longevity thanks to heat-treated steel blade
- Cutting height: max. 5 sheets 80g/m² (0.5 mm)

00008224

54 BK

Photo-Studio





hama

Bracket for Background Rolls, 3x, Hama System

Material	Plastic Material
Number of Hooks	3
Length	40 cm
Weight	1.04 kg

- For 3 background axes with Hama system
- Suitable for insert spindle item no. 00021210, aluminium tube 275 cm item no. 00021211, aluminium tube 360 cm item no. 00021212
- Wall or ceiling mounting
- With mounting screws and dowels
- With drilling template and mounting diagram
- Impact-resistant plastic

Black				00021200
		1	SC	

Half Spindle



hama

Background Aluminium Tube Axle, 360 cm, Hama System

Maximum Load Capacity	25 kg
Weight	12 kg

- For 3x brackets for background rolls, item no. 00021200 System Hama
- The end-to-end aluminium pipes prevent the background cardboard from sagging and therefore creasing
- Unrolling stop
- Metal chain
- Clamp device for cardboard tubes
- Load capacity max. 25 kg
- Weight

360 cm				00021212
		1	K.A.	



hama

Background Aluminium Tube Axle, 275 cm, Hama System

Maximum Load Capacity	5.5 kg
Weight	10 kg

- For 3x brackets for background rolls, item no. 00021200 System Hama
- The end-to-end aluminium pipes prevent the background cardboard from sagging and therefore creasing
- Unrolling stop
- Metal chain
- Clamp device for cardboard tubes
- Load capacity max. 14 kg
- Weight

275 cm				00021211
		1	K.A.	



hama

Background Insert Spindles, 2-Part, Hama System

Maximum Load Capacity	5.5 kg
Weight	2.7 kg

- For 3x brackets for background rolls, item no. 00021200, System Hama
- Clamp device for cardboard tube
- Unrolling stop
- Metal chain
- The axle parts are pushed into the cardboard tube from the left or right
- Weight
- For roll widths from 80 - 275 cm
- Only for rolls on cardboard core with internal diameter of 54 - 65 mm

275 cm				00021210
		3	SC	

Locking Cone



hama

Background Fixing Cone, Hama System

Material	Metal
----------	-------

- Allows background rolls on cardboard tubing of any width (depending on the axle) to be fixed in place
- Examples: background cardboard 275 cm on axle 360 cm/background axle 135 cm on axle 275 cm
- Securing cuff
- Weight

Grey				00021235
		1	SC	

Weighting Rail



hama

Weighting rail for all photo backgrounds

Shade of colour	Silver
-----------------	--------

- The rail is attached to the bottom of the background cardboard and keeps it hanging flat or secured to the floor
- 4 fastening clips

2.75 m	00021213
1	K.A.

Hook and Loop Tape



hama

"Studio" Hook and Loop Tape, 2 m

Shade of colour	Black
Material	Nylon
Width x Length	5 x 200 cm

- 2 m loop tape (width: 50 mm), 2 m hook tape (width: 25 mm)
- Self-adhesive
- Also suitable for fixing decorations

00022290
6 BK

Umbrella Holder

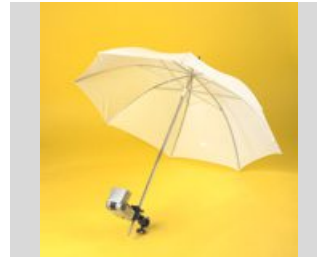

hama

Umbrella Holder for Flash Units with Attachment Foot

Shade of colour	Black
-----------------	-------

- With spigot adapter for use on tripod sockets A 1/4" (6.4 mm)
- Without adapter can be used for larger diameters up to 1.5 cm
- Studio umbrella is attached to the insert hole with a spring, suitable for all common umbrella diameters
- Joint for inclining the flash and umbrella by 90° in both directions
- Standard flash rail with locking screw for secure fixing
- Suitable for all stands up to 1.5 cm

00006079
3 BK

Mini Photo Studio



hama

"ToGo" Mobile Mini Photo Studio, Folding Photo Box with LED Ring Light, 50x

Width x Depth x Height	50 x 50 x 50 cm
------------------------	-----------------

- Foldable photo box: this little mini studio can be folded down to a trim 3 cm in height and takes up barely any space when on the move
- Light box with accessories: the little photo studio including LED ring light, diffuser fabric and colour backgrounds contains everything you need for good product photography
- Take them easily yourself: great product images even without any in-depth knowledge of professional product photography - and without any major costs
- From warm white to daylight bright: control the colour temperature in 3 stages using the cable remote control for optimised and even lighting
- From radiantly bright to pleasantly dimmed: the light intensity can be adjusted in 10 stages
- LED lights are economical and thus more durable than conventional lamps
- Always the right mood: the mobile photo studio set for product photography contains 6 backgrounds to ensure the right colour for every scenario, be it classic white, sleek beige or green
- Photo studio to go: the light box can be packed up extremely small for transport and storage and is a piece of essential equipment for all online traders and photographers who like to be flexible and practical
- Fast light cube setup: simply apply hook-and-loop fastener to the edges and attach them to each other
- Great lighting: integrated ring light with 10.2" (ø 25 cm) and 128 LEDs on the top of the light cube

00004664
6 HB

Adhesive Paste



hama

Adhesive Paste, 250 g

- Kneadable
- For support
- Is simply applied to the product
- Neutral grey
- Can be coloured with a felt pen or similar on the surface
- Permanently elastic
- No skin formation
- Does not become brittle
- Self-adhesive

Grey				00007091
		28	SC	

Laboratory Glove



hama

Cotton Gloves, Size M, 1 Pair, white

Material	Cotton
----------	--------

- To avoid fingerprints on optical surfaces, slides and negatives
- Prevent finger prints on objects being photographed
- Ideal for gentle cleaning and for work on optical parts or films, as well as antiques
- For laboratory and precision engineering work
- Also suitable for cooking, domestic and hobby use
- Maximum wearing comfort - skin-friendly, breathable and pleasant to wear
- Soft cotton and gentle seams: fabric gloves can be worn all day long as well as overnight

M				00008410
		100	HB	

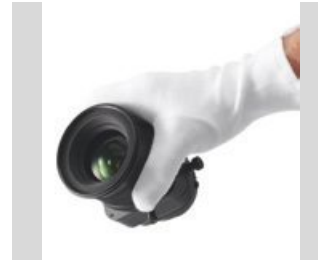

hama

Cotton Gloves, Size XL, 1 Pair, white

Material	Cotton
----------	--------

- To avoid fingerprints on optical surfaces, slides and negatives
- Prevent finger prints on objects being photographed
- Ideal for gentle cleaning and for work on optical parts or films, as well as antiques
- For laboratory and precision engineering work
- Also suitable for cooking, domestic and hobby use
- Maximum wearing comfort - skin-friendly, breathable and pleasant to wear
- Soft cotton and gentle seams: fabric gloves can be worn all day long as well as overnight

XL				00008411
		100	HB	

Matt Spray



hama

Matt Spray

- Wash-out spray
- Can be removed again with water

400 ml				00006619
		6		

Background Carton

Photo Background



hama

"2in1" Folding Background, Green/Blue, 150 x 200 cm

Material	Cotton
Width x Length	1.5 x 2 m

- Mobile folding background for streaming, gaming and video conferences in the office, home office and leisure domain
- Can be set up in seconds
- Two-colour background (green front / blue rear), ideal for photo and video recordings that can be cropped and digitally edited
- With fastening loops (1 x short side / 2 x long side)

				00021570
	3	SC		



hama

Photo Studio Background, Fabric, 2.95 x 6 m, white

Material	Cotton
Width x Length	2.95 x 6 m

- The photo background made from hard-wearing fabric can be used in many different ways, even without fixed background mounting
- Photo studio to go: for more picture depth, you can simply hang the fabric background over a sofa, chair or cabinet, making it ideal for all bloggers and vloggers who are on the move a lot

White				00021156
	6	SC		



hama

Bluescreen Background, Fabric, 2.95 x 6 m, royal blue

Material	Cotton
Width x Length	2.95 x 6 m

- The photo background made from hard-wearing fabric can be used in many different ways, even without fixed background mounting
- Photo studio to go: for more picture depth, you can simply hang the fabric background over a sofa, chair or cabinet, making it ideal for all bloggers and vloggers who are on the move a lot

Royal Blue				00021159
	6	SC		



hama

Greenscreen Background, Fabric, 2.95 x 6 m, green

Material	Cotton
Width x Length	2.95 x 6 m

- The photo background made from hard-wearing fabric can be used in many different ways, even without fixed background mounting
- Photo studio to go: for more picture depth, you can simply hang the fabric background over a sofa, chair or cabinet, making it ideal for all bloggers and vloggers who are on the move a lot

Green				00021158
	6	SC		



hama

Photo Studio Background, Fabric, 2.95 x 6 m, black

Material	Cotton
Width x Length	2.95 x 6 m

- The photo background made from hard-wearing fabric can be used in many different ways, even without fixed background mounting
- Photo studio to go: for more picture depth, you can simply hang the fabric background over a sofa, chair or cabinet, making it ideal for all bloggers and vloggers who are on the move a lot

Black				00021157
	6	SC		



hama

Background 1,35 x 11 m, arctic white

Material	Cardboard
Width x Length	1.35 x 11 m

- Coloured paper background, matt, non-fading, on a cardboard core

Arctic White				00021493
	1	K.A.		

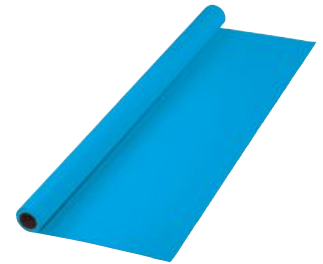

hama

Background 1,35 x 11 m, nassau blue

Material	Cardboard
Width x Length	1.35 x 11 m

- Coloured paper background, matt, non-fading, on a cardboard core

Nassau Blue				00021406
	1	K.A.		



hama

Background 1,35 x 11 m, navy blue

Material	Cardboard
Width x Length	1.35 x 11 m

- Coloured paper background, matt, non-fading, on a cardboard core

Navy Blue				00021441
	1	K.A.		

Background Carton



hama

Background 1,35 x 11 m, blue

Material	Cardboard
Width x Length	1.35 x 11 m

- Coloured paper background, matt, non-fading, on a cardboard core

Blue	00021460
1	K.A.



hama

Background 1,35 x 11 m, sand

Material	Cardboard
Width x Length	1.35 x 11 m

- Coloured paper background, matt, non-fading, on a cardboard core

Sand	00021466
1	K.A.



hama

Background 1,35 x 11 m, yellow

Material	Cardboard
Width x Length	1.35 x 11 m

- Coloured paper background, matt, non-fading, on a cardboard core

Yellow	00021414
1	K.A.



hama

Background 1,35 x 11 m, light gold

Material	Cardboard
Width x Length	1.35 x 11 m

- Coloured paper background, matt, non-fading, on a cardboard core

Light Gold	00021418
1	K.A.



hama

Background 1,35 x 11 m, beige

Material	Cardboard
Width x Length	1.35 x 11 m

- Coloured paper background, matt, non-fading, on a cardboard core

Beige	00021425
1	K.A.



hama

Background 1,35 x 11 m, fawn brown

Material	Cardboard
Width x Length	1.35 x 11 m

- Coloured paper background, matt, non-fading, on a cardboard core

Fawn Brown	00021467
1	K.A.



hama

Background 1,35 x 11 m, orange

Material	Cardboard
Width x Length	1.35 x 11 m

- Coloured paper background, matt, non-fading, on a cardboard core

Orange	00021439
1	K.A.



hama

Background 1,35 x 11 m, light grey

Material	Cardboard
Width x Length	1.35 x 11 m

- Coloured paper background, matt, non-fading, on a cardboard core
- Especially suited for passport photos according to the new ePass guidelines

Light Grey	00021423
1	K.A.

Background Carton



hama

Background 1,35 x 11 m,
dove-grey

Material	Cardboard
Width x Length	1.35 x 11 m

- Coloured paper background, matt, non-fading, on a cardboard core
- Especially suited for passport photos according to the new ePass guidelines

Dove-Grey	00021443
1	K.A.



hama

Background 1,35 x 11 m,
neutral grey

Material	Cardboard
Width x Length	1.35 x 11 m

- Coloured paper background, matt, non-fading, on a cardboard core
- Especially suited for passport photos according to the new ePass guidelines

Neutral Grey	00021404
1	K.A.



hama

Background 1,35 x 11 m,
apple-green

Material	Cardboard
Width x Length	1.35 x 11 m

- Coloured paper background, matt, non-fading, on a cardboard core

Apple Green	00021463
1	K.A.



hama

Background 1,35 x 11 m,
scarlet

Material	Cardboard
Width x Length	1.35 x 11 m

- Coloured paper background, matt, non-fading, on a cardboard core

Scarlet	00021456
1	K.A.



hama

Background 1,35 x 11 m,
lead-grey

Material	Cardboard
Width x Length	1.35 x 11 m

- Coloured paper background, matt, non-fading, on a cardboard core

Livid	00021457
1	K.A.



hama

Background 1,35 x 11 m,
dark green

Material	Cardboard
Width x Length	1.35 x 11 m

- Coloured paper background, matt, non-fading, on a cardboard core

Dark Green	00021412
1	K.A.



hama

Background 1,35 x 11 m,
fiery red

Material	Cardboard
Width x Length	1.35 x 11 m

- Coloured paper background, matt, non-fading, on a cardboard core

Fiery Red	00021427
1	K.A.



hama

Background 1,35 x 11 m,
violet

Material	Cardboard
Width x Length	1.35 x 11 m

- Coloured paper background, matt, non-fading, on a cardboard core

Violet	00021468
1	K.A.

Background Carton



hama

Background 1,35 x 11 m,
black

Material	Cardboard
Width x Length	1.35 x 11 m

- Coloured paper background, matt, non-fading, on a cardboard core

Black	00021444
1	K.A.



hama

Background 2,75 x 11 m,
arctic white

Material	Cardboard
Width x Length	2.75 x 11 m

- Coloured paper background, matt, non-fading, on a cardboard core

Arctic White	00021593
1	K.A.



hama

Background 2,75 x 11 m,
light blue

Material	Cardboard
Width x Length	2.75 x 11 m

- Coloured paper background, matt, non-fading, on a cardboard core

Light Blue	00021502
1	K.A.



hama

Background 2,75 x 11 m,
navy blue

Material	Cardboard
Width x Length	2.75 x 11 m

- Coloured paper background, matt, non-fading, on a cardboard core

Navy Blue	00021541
1	K.A.



hama

Background 1,35 x 11 m,
natural silk

Material	Cardboard
Width x Length	1.35 x 11 m

- Coloured paper background, matt, non-fading, on a cardboard core

Natural Silk	00021426
1	K.A.



hama

Background 2,75 x 11 m,
deep blue

Material	Cardboard
Width x Length	2.75 x 11 m

- Coloured paper background, matt, non-fading, on a cardboard core

Deep Blue	00021501
1	K.A.



hama

Background 2,75 x 11 m,
nassau blue

Material	Cardboard
Width x Length	2.75 x 11 m

- Coloured paper background, matt, non-fading, on a cardboard core

Nassau Blue	00021506
1	K.A.



hama

Background 2,75 x 11 m,
turquoise

Material	Cardboard
Width x Length	2.75 x 11 m

- Coloured paper background, matt, non-fading, on a cardboard core

Turquoise	00021555
1	K.A.

Background Carton



hama

Background 2,75 x 11 m, sea blue

Material	Cardboard
Width x Length	2.75 x 11 m

- Coloured paper background, matt, non-fading, on a cardboard core

Water Blue	00021561
1	K.A.



hama

Background 2,75 x 11 m, beige

Material	Cardboard
Width x Length	2.75 x 11 m

- Coloured paper background, matt, non-fading, on a cardboard core

Beige	00021525
1	K.A.



hama

Background 2,75 x 11 m, sand

Material	Cardboard
Width x Length	2.75 x 11 m

- Coloured paper background, matt, non-fading, on a cardboard core

Sand	00021566
1	K.A.



hama

Background 2,75 x 11 m, yellow

Material	Cardboard
Width x Length	2.75 x 11 m

- Coloured paper background, matt, non-fading, on a cardboard core

Yellow	00021514
1	K.A.



hama

Background 2,75 x 11 m, dark brown

Material	Cardboard
Width x Length	2.75 x 11 m

- Coloured paper background, matt, non-fading, on a cardboard core

Dark Brown	00021520
1	K.A.



hama

Background 2,75 x 11 m, brown

Material	Cardboard
Width x Length	2.75 x 11 m

- Coloured paper background, matt, non-fading, on a cardboard core

Brown	00021548
1	K.A.



hama

Background 2,75 x 11 m, fawn brown

Material	Cardboard
Width x Length	2.75 x 11 m

- Coloured paper background, matt, non-fading, on a cardboard core

Fawn Brown	00021567
1	K.A.



hama

Background 2,75 x 11 m, yellow-orange

Material	Cardboard
Width x Length	2.75 x 11 m

- Coloured paper background, matt, non-fading, on a cardboard core

Orange, Yellow	00021535
1	K.A.

Background Carton



hama

Background 2,75 x 11 m, orange

Material	Cardboard
Width x Length	2.75 x 11 m

- Coloured paper background, matt, non-fading, on a cardboard core

Orange	00021539
1	K.A.



hama

Background 2,75 x 11 m, light gold

Material	Cardboard
Width x Length	2.75 x 11 m

- Coloured paper background, matt, non-fading, on a cardboard core

Light Gold	00021518
1	K.A.



hama

Background 2,75 x 11 m, light grey

Material	Cardboard
Width x Length	2.75 x 11 m

- Coloured paper background, matt, non-fading, on a cardboard core
- Especially suited for passport photos according to the new ePass guidelines

Light Grey	00021523
1	K.A.



hama

Background 2,75 x 11 m, dove-grey

Material	Cardboard
Width x Length	2.75 x 11 m

- Coloured paper background, matt, non-fading, on a cardboard core
- Especially suited for passport photos according to the new ePass guidelines

Dove-Grey	00021543
1	K.A.



hama

Background 2,75 x 11 m, lead-grey

Material	Cardboard
Width x Length	2.75 x 11 m

- Coloured paper background, matt, non-fading, on a cardboard core

Livid	00021557
1	K.A.



hama

Background 2,75 x 11 m, slate-grey

Material	Cardboard
Width x Length	2.75 x 11 m

- Coloured paper background, matt, non-fading, on a cardboard core
- Especially suited for passport photos according to the new ePass guidelines

Slate Grey	00021558
1	K.A.



hama

Background 2,75 x 11 m, neutral grey

Material	Cardboard
Width x Length	2.75 x 11 m

- Coloured paper background, matt, non-fading, on a cardboard core
- Especially suited for passport photos according to the new ePass guidelines

Neutral Grey	00021504
1	K.A.



hama

Background 2,75 x 11 m, dark green

Material	Cardboard
Width x Length	2.75 x 11 m

- Coloured paper background, matt, non-fading, on a cardboard core

Dark Green	00021512
1	K.A.

Background Carton



hama

Background 2,75 x 11 m,
aspen

Material	Cardboard
Width x Length	2.75 x 11 m

- Coloured paper background, matt, non-fading, on a cardboard core

Aspen	00021550
1	K.A.



hama

Background 2,75 x 11 m, pink

Material	Cardboard
Width x Length	2.75 x 11 m

- Coloured paper background, matt, non-fading, on a cardboard core

Pink	00021517
1	K.A.



hama

Background 2,75 x 11 m, lilac

Material	Cardboard
Width x Length	2.75 x 11 m

- Coloured paper background, matt, non-fading, on a cardboard core

Purple	00021529
1	K.A.



hama

Background 2,75 x 11 m,
scarlet

Material	Cardboard
Width x Length	2.75 x 11 m

- Coloured paper background, matt, non-fading, on a cardboard core

Scarlet	00021556
1	K.A.



hama

Background 2,75 x 11 m,
apple-green

Material	Cardboard
Width x Length	2.75 x 11 m

- Coloured paper background, matt, non-fading, on a cardboard core

Apple Green	00021563
1	K.A.



hama

Background 2,75 x 11 m, fiery
red

Material	Cardboard
Width x Length	2.75 x 11 m

- Coloured paper background, matt, non-fading, on a cardboard core

Fiery Red	00021527
1	K.A.



hama

Background 2,75 x 11 m,
crimson

Material	Cardboard
Width x Length	2.75 x 11 m

- Coloured paper background, matt, non-fading, on a cardboard core

Crimson	00021549
1	K.A.



hama

Background 2,75 x 11 m, red
violet

Material	Cardboard
Width x Length	2.75 x 11 m

- Coloured paper background, matt, non-fading, on a cardboard core

Red, Violet	00021562
1	K.A.

Background Carton



hama

Background 2,75 x 11 m, violet

Material	Cardboard
Width x Length	2.75 x 11 m

- Coloured paper background, matt, non-fading, on a cardboard core

Violet	00021568
1	K.A.



hama

Background 2,75 x 11 m, natural silk

Material	Cardboard
Width x Length	2.75 x 11 m

- Coloured paper background, matt, non-fading, on a cardboard core

Natural Silk	00021526
1	K.A.



hama

Background 2,75 x 11 m, ivory

Material	Cardboard
Width x Length	2.75 x 11 m

- Coloured paper background, matt, non-fading, on a cardboard core

Ivory	00021533
1	K.A.



hama

Background, Cardboard, 2.75 x 11 m, Green-Screen-Compatible, mint green

Material	Cardboard
Width x Length	2.75 x 11 m

- Ideal for photo and video recordings that can be cropped and digitally edited
- Mass-dyed background, matt, light-proof, on cardboard tube

Mint green	00021534
1	K.A.



hama

Background 2,75 x 11 m, black

Material	Cardboard
Width x Length	2.75 x 11 m

- Coloured paper background, matt, non-fading, on a cardboard core

Black	00021544
1	K.A.



hama

Background 2,75 x 11 m, snow white

Material	Cardboard
Width x Length	2.75 x 11 m

- Coloured paper background, matt, non-fading, on a cardboard core
- Especially suited for passport photos according to the new ePass guidelines

Snow-White	00021528
1	K.A.



hama

Background 2,75 x 11 m, light ivory

Material	Cardboard
Width x Length	2.75 x 11 m

- Coloured paper background, matt, non-fading, on a cardboard core

Light Ivory	00021564
1	K.A.



hama

Background, Cardboard, 3.60 m x 30 m, black

Material	Cardboard
Width x Length	3.6 x 30 m

- Especially thick cardboard, bulk-dyed, light-fast, matt, 360 cm wide, on cardboard tube

Black	00021147
1	K.A.

Background Carton



hama

**Background, Cardboard,
3.60 m x 30 m, dove grey**

Material	Cardboard
Width x Length	3.6 x 30 m

- Especially thick cardboard, bulk-dyed, light-fast, matt, 360 cm wide, on cardboard tube

Dove-Grey	00021148
1	K.A.



hama

**Background, Cardboard,
3.60 m x 30 m, Arctic white**

Material	Cardboard
Width x Length	3.6 x 30 m

- Especially thick cardboard, bulk-dyed, light-fast, matt, 360 cm wide, on cardboard tube
- Especially suitable for passport photographs compliant with the new EU passport guidelines

Arctic White	00021146
1	K.A.



hama

**"Chairy" Folding Background,
for Attachment to Chair
Backs, green, Ø 130 cm**

Material	Nylon
----------	-------

- Mobile folding background for streaming, gaming and video conferences in the office, home office and leisure domain
- Ideal for photo and video recordings that can be cropped and digitally edited
- Can be set up in seconds and attached using the universal fixing loop to any conventional chair (for chair backs with a width of approx. 35 cm - 65 cm)

Green	00021572
12	SC

Sample assortment



hama

**Colour Sample Card Back-
ground Cardboard**

	00021104
--	-----------------

250	PO
-----	----

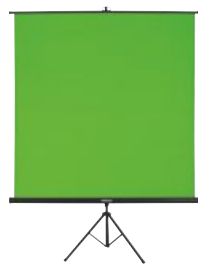

hama

**Green Screen Background
with Tripod, 180 x 180 cm,
2 in 1**

Width x Length	180 x 180 m
----------------	-------------

- The green-screen background with quick-release clip can be removed from the tripod and hung up on its own
- The spring mechanism allows the green screen to be easily extended to the required size and secured in place, remaining crease-free in the process
- Continually adjustable telescope tube (total height 235 - 270 cm)

	00021571
1	SC

Optical Products



Holder



hama

"Alu" Binoculars Tripod Holder with 1/4" Thread

Material	Aluminium
----------	-----------

- For wobble-free and lengthy observation since both hands remain free
- Firm position of the binoculars on the adapter and tripod
- Easy mounting of the binoculars: simply screw the adapter to the tripod and the binoculars to the adapter
- The binoculars remain fully operable
- Suitable for all binoculars with a 1/4" thread
- Adapter suitable for all tripods with 1/4" (6.4 mm) thread / connection

Black	00002809
6 BK	

Clamp/Tension Bracket



hama

Smartphone Holder for Spotting Scope/Binoculars/Telescope with Ø 2.5-4.8 cm

Attachment	Tripod Thread 1/4"
Material	Metal
Model	Spotting Scope / Binoculars / Telescope

- Telephoto lens for the smartphone camera: maximum magnification factor for impressive shots with the smartphone via binoculars, telescopes and so on
- Suitable for smartphones with a width of 5.5 cm to 9.5 cm
- Also suitable for spotting scopes, binoculars, telescopes and microscopes featuring eyepieces with a diameter from 2.5 cm to 4.8 cm
- Easy attachment of the smartphone holder to the eyepiece using the screw connection
- The smartphone is secured in a clamping bracket with a screw mechanism
- Clamping bracket and resting surface rubberised and padded – for optimal protection against scratches
- Compact and space-saving, also ideal for luggage
- Share sensational photos and videos directly in social media
- Also suitable as a smartphone holder for tripods with 1/4" standard thread

Black	00044343
6 HB	

Binoculars



hama

Binoculars, 10x50 Prism

Shade of colour	Black
Armouring	Rubber
Design	Porro
Diameter of Exit Pupil	5 mm
Field of View /1000 m	101 m
Focusing	Joint Focusing Arrangement
Lens Coating	Coated
Weight	830 g

- The "Blue Coated" antireflection lens coating avoids reflections thus guaranteeing a clear image, especially in case of backlight and dusk or dawn
- Soft touch body for shock protection and an optimal grip, therefore ideal for travel, sport and leisure time
- Due to reversible eyecups also suitable for wearers of glasses
- Compensates up to +/-3 diopters thus delivering clear images for spectacle wearers
- Quick and easy to focus thanks to large focusing wheel
- 1/4" (6.4 mm) thread allows you to attach a tripod (includes thread cover)

10x 50 mm	00002804
8 SC	

Magnifier



hama

"Basic 75" Magnifying Glass, 12 pcs. in display

Shade of colour	Black
Max. Magnification Factor	1.75
Height	80 mm
Lens Diameter	75 mm
Width	80 mm

- With convenient handle
- 75 mm diameter for optimum visibility
- Also perfect as a practical vision aid for the elderly to help them read comfortably and independently

	00005441
12 SC	



hama

"Basic 90 LED" Reading Magnifier, 18 pcs. in display

Shade of colour	Black
Max. Magnification Factor	4
Height	94 mm
Lens Diameter	90 mm
Width	202 mm

- With LED light (2 LEDs)
- With convenient, slim handle
- Large lens diameter 90 mm (2 x magnification) for the best view
- Small lens diameter 21 mm (4 x magnification) for detailed magnification

	00005445
18 SC	

Company headquarters

Hama GmbH & Co KG
Dresdner Str. 9
86653 Monheim/Bavaria
GERMANY
Tel. +49 9091 502-0
Fax +49 9091 502-274
info.de@hama.com
www.hama.com

www.facebook.com/Hama.Germany

All brand names listed are trade marks of the corresponding companies.
Errors and changes to technology and design are reserved.
Our general terms and conditions of business apply. Printed in Germany.

097904/11.2024



hama